

<http://www.replacementdocs.com>

**CODES AND PROCEDURES
OF THE WARRIOR CASTE**

Therefore the youngest of them all stood up,
And with a voice like amber wine she spoke:
"Great sir, now all is clear and seeming well,
Yet still there is but one remaining problem;
My children, sir, they as of yet unborn,
Shall never hear your words so pure and grand."
"You see" the great one spoke aloud, "It is
your humble kin for whom I write this book.
It is the law, our honor bound in hide."

—The Remembrance
Passage 156, Verse 4, Lines 24-32

PREFACE

This book outlines the codified rules of behavior all members of the Warrior Caste are expected to uphold. It is the very definition of what it means to be a MechWarrior. You must study it well, for ignorance of its contents is grounds for caste demotion.

Each passage represents centuries of testing and modification, trial and error. The protocol contained herein has descended from Kerensky's own words. There are only two books that are older than this one and still being read, *The Remembrance* and one other. You are therefore expected to live and die by its instructions.

The Warrior Caste is above all others in the Clan. The Laborer, the Technician, the Merchant and the Scientist all look to you for guidance, for you are the most perfect of all perfection. The Warrior is the very top of culture. You are the teacher and the protector, the governor and the parent.

As a MechWarrior you will fight in the Touman for the glory of the Clans. There is no higher honor, no greater glory, than to enter combat outnumbered by the largest margin possible and emerge victorious.

Your tool in the field is the BattleMech. It is your mount. You will learn to pilot it. You will become part of it and it, you. The BattleMech is designed to translate your will into the actions of the machine. As a MechWarrior, your very thoughts equal your foe's defeat.

Combat is your life. Fear not death. The honorable will find their end in the field. Honor is the lifeblood of the MechWarrior. Without honor the MechWarrior is worth less than the dust whence he came. There is no virtue above honor. Without honor there is not life.

TABLE OF CONTENTS

TRIALS OF GRIEVANCE	1
Instant Action	1
• Scenario	1
• Friendly Clan/ Enemy Clan	1
• 'Mech Lab	2
• Star	2
NON-COMBAT PROTOCOL	3
Registration	3
Cadet Training	3
Clan Archive	4
Career Advancement	4
• Clan Trials of Position	5
• Ranking Structure	5
• Hall of Honor	5
• Rules of Engagement	6
PRE-LAUNCH PROTOCOL	7
Mission Briefing	7
• Mission Types	7
• Mission Objectives	7
• Situational Report	8
BattleMech Selection	8
• 'Mech Types	8
• BattleMech Components	12
• Balancing a 'Mech	14
Star Configuration	15

• Tactical Star Formations	16
Cockpit Controls	17
Combat Variables	17
• Difficulty	17
• Audio	17
• Detail	18
• Altered Reality	18
Launch	19
Debriefing	19
COMBAT PROTOCOL	20
Basic Piloting	20
• Heat Management	20
• Neural-Impulse Control	21
• Throttle	21
• Steering	22
• Torso Twist	22
• Pilot Eye Control	22
• External Tracking Camera (XTC)	22
• Satellite Uplink	23
• Low-Light Amplification	23
Heads-Up Display Systems (HUD)	23
Battle Parameters	28
• Abort Mission	28
• Device Calibration	28
• Audio Control	28
• Performance Settings	28
• Deserting the Battlefield (Flee to DOS) ...	29
Navigation	29
• NAV Points	29
• Auto-Pilot	29
Targeting	30
• Targeting Info and Ranges	30
• Target View	30
• Inspection	31

Weaponry	31
• Weapons System Breakdown	31
• Grouping Weapons	33
• Chain-Fire vs. Group-Fire	33
• Jettison Ammunition	34
Damage and Critical Hits	34
Advanced Piloting	35
• Jump Jetting	35
• MASC	36
• Manual Shutdown	36
• Pilot Auto-Ejection	36
• Enhanced Imaging	36
• Commanding Starmates	37
Environmental Conditions	38
APPENDICES	40
Appendix A — Default Control Configuration Systems	40
Appendix B — Procedures for Customizing a BattleMech	44
Appendix C — Weapons Systems	49
Appendix D — Diagrams of the BattleMechs (Primary Configurations)	53
Appendix E — Glossary	68
Appendix F — NetMech for MS-DOS	70
CREDITS	79

TRIALS OF GRIEVANCE

INSTANT ACTION

Trials of Grievance can be called by MechWarriors to resolve conflicts against other warriors who have displayed dishonorable behavior. Trial of Grievance protocol requires MechWarriors to report for instant action upon being called to a Trial. The opposing warrior must accept this challenge for no other reason than to defend his honor. Clan members have been known to call Trials of Grievance against other warriors simply out of envy of another warrior's performance or Clan ranking. Trials can be fought regardless of a MechWarrior's current Clan rank since they neither progress nor hinder a BattleMech pilot's advancement.

To engage in immediate battle, a MechWarrior need only accept the conditions of the scenario and give the order to **LAUNCH**.

SCENARIO

A MechWarrior calling a Trial of Grievance has the right to select the battlefield upon which he wishes to engage in battle. A MechWarrior need only select the planet of choice to determine the atmospheric conditions and terrain characteristics that are to affect the imminent engagement.

FRIENDLY CLAN/ENEMY CLAN

■ 'Mech Deployment

MechWarriors can choose to lead a Star of up to three BattleMechs to a Trial of Grievance. However, employing excessive tonnage or deploying more 'Mechs than the opposing Clan has committed to defies Trial of Grievance protocol. The Keshik advises that MechWarriors take caution in the selection of BattleMech technology — unfair or wasteful deployment of Friendly and Enemy technology will not be tolerated.



■ Star Formation

A commander of a Star can select tactical Star formations prior to launch. By determining the general starmate positions from the Trial of Grievance display, a MechWarrior can issue an immediate Star formation order. Refer to "Tactical Star Formations" in the **Pre-Launch Protocol** section.

■ Clan Affiliation

Before launching on a Trial of Grievance, a MechWarrior must identify his Clan affiliation by displaying his Clan symbol under **Friendly Star**. Then he must confirm the Clan that he is calling to a Trial of Grievance by identifying the Enemy Clan symbol: Jade Falcon, Wolf, Ghost Bear, Nova Cat, Steel Viper or Smoke Jaguar.

'MECH LAB

The 'Mech Design Lab allows commanders of a Star to view the 'Mech technology they will be leading into battle. It also allows experienced MechWarriors to deploy customized BattleMech designs into combat. Commanders can access the 'Mech Lab Holoprojector to select different BattleMechs for themselves or to assign to their starmates. Refer to **Appendix B – Procedures for Customizing a BattleMech**.

STAR

MechWarriors engaging in Trials of Grievance can ready themselves for battle by re-assigning the positions of the current 'Mechs in their Star unit to the three different points in a Star configuration. Upon issuing the **STAR** command to activate the Star Configuration Holoprojector, MechWarriors can review the Star positions of each of the 'Mech they will be leading into the Trial of Grievance. Refer to "Star Configuration" in the **Pre-Launch Protocol** section



NON-COMBAT PROTOCOL

REGISTRATION

Upon entering the **CLAN HALL**, all pilots within a sibling company are required to register their pilot names on the sibko roster. Upon activating the **REGISTRATION** orb, a MechWarrior's rank and vital statistics are also recorded in order to complete the required pilot sign-in.

CADET TRAINING

It is recommended that all cadets undergo rigorous training drills prior to solo piloting on advanced 'Mech combat missions. Cadets are advised to report to **CADET TRAINING** immediately following registration. Once inside the Training Quarters, cadets should review the standard training missions and await instruction on NAV Computer training. Each drill brings green pilots one step closer to their first Trial of Position in which cadets will have the opportunity to battle for the rank of MechWarrior.

■ NAV Computer

Designed to teach cadets to navigate by following a NAV sequence while mastering the basic movement controls of a 'Mech.

■ 'Mech Handling

Requires a pilot to practice advanced 'Mech throttle and steering techniques by running a 'Mech through a slalom.

■ Weapons Usage

Hones cadet targeting skills using on-board weapons systems to hit various targets while challenging 'Mech maneuvering skills in "The Gauntlet."



*LISTEN TO
INSTRUCTOR —
WILL NOT
REPEAT
INSTRUCTIONS!*

*WATCH TURNS
AROUND PYLONS
OR DAMAGE
'MECH!*

■ **Hunting**

Takes training cadets on a hunting-and-killing expedition against a drone 'Mech.

■ **Inspection**

Instructs cadets to inspect likely targets and investigate their contents while under fire.

■ **Trial of Position**

Initiates a cadet in his first trial where he must hunt and destroy a veteran MechWarrior in one-on-one combat for a chance to earn the rank of MechWarrior.

JUMP →
JETS ON A
TIMBERWOLF
CONFIG?

CLAN ARCHIVE

Registration gives MechWarriors unlimited access to the **ARCHIVE HOLOPROJECTOR**, the repository of all knowledge of the Clans. This immense research facility, once the place where the great IlKahns went to conduct studies on diverse subjects, holds exclusive Clan intelligence. IlKahns could access information on the historical combat techniques of the greatest Clan warriors or the technological differences of various BattleMech configurations. The Clan Archive offers classified information that could prove to better prepare a MechWarrior before launching combat missions against enemies of unknown worlds.

CAREER ADVANCEMENT

A MechWarrior shall earn the right of advancement through his career as determined by the Keshik war council. The Keshik actively evaluates the performance of each combat engagement a MechWarrior accepts, recording victorious performance as well as that which is deemed dishonorable by the Clan. The Keshik duly rewards MechWarriors demonstrating exceptional piloting skills and a superior use of weaponry that adhere to Clan rules of engagement. The Keshik shall advise a MechWarrior of his eligibility for Clan advancement upon substantiation of a warrior's merit.



CLAN TRIALS OF POSITION

Upon thorough evaluation by the Keshik, a MechWarrior deemed worthy of advancement in rank will be notified of his right to participate in a **Trial of Position**. Clan protocol for such privileged battles requires a candidate to succeed in two distinct phases of a **Trial of Position** to be granted all ranks in question. The first phase requires the honorable defeat of all engaging 'Mech opponents. Once all opponents in Phase 1 are destroyed, the candidate will receive the trial moderator's audio cue to continue. The audio signal will instruct the candidate to target and **destroy a specified non-'Mech target – the Engagement Sphere – for Phase 2 officially to begin**. If the candidate destroys the target before the cue, he will be forced to engage both Phase 1 and Phase 2 'Mechs simultaneously. Upon completing Phase 1, the candidate can choose to retain the rank earned or continue the Trial for the right to earn a second rank. If the candidate accepts the second phase by destroying the Engagement Sphere within 15 seconds of the audio cue, he must proceed to defeat all Phase 2 opponents in order to succeed in the **Trial of Position** and earn the right to advance two Clan ranks. Should a candidate accept to continue, but fail to succeed in Phase 2, he must depart the Trial without earning a single rank.



REMEMBER
SITUATIONARY
'MECHS!
HOLD FIRE
AND DON'T
ENGAGE
UNTIL HIT!

RANKING STRUCTURE

A BattleMech pilot begins his career as a MechWarrior – the lowest-ranking member of the Warrior Caste with the right to command a 'Mech. A MechWarrior's ultimate goal is to become Khan of his Clan. For this highest honor, a MechWarrior must excel throughout his career by achieving each possible rank and surpassing the highest levels of Clan honor before being invited to the last Trial of Position for Galaxy Commander and Khan.

1st Rank	– MechWarrior	6th Rank	– Star Colonel
2nd Rank	– Star Commander	7th Rank	– Nova Colonel
3rd Rank	– Nova Commander	8th Rank	– Galaxy Commander
4th Rank	– Star Captain	Top Rank	– Khan
5th Rank	– Nova Captain		

HALL OF HONOR

The Hall of Honor reveres the pilots that have earned the overall highest honor in battle. These master warriors are archived by name, rank, honor and skill.

ESC

MW
ST. CMD
NV. CMD
ST. CPT
NV. CPT
ST. COL
NV. COL
G. CMD

} ABBREV

RULES OF ENGAGEMENT

We are bound by the rules and traditions of our great forefathers to uphold the honor and glory of the Clans. Clan warfare follows a strict code of honor – a glorious method that is designed to preserve life rather than destroy it. Only warriors adhering to such codes shall emerge victorious and worthy of the honor of being BattleMech pilots. MechWarriors shall strive for perfection in combat, perfection in the life of a warrior – all for the glory of the Clans.

- The successful completion of the primary objectives of a mission shall bestow unto a MechWarrior the glory of a victorious battle.
- Performance beyond the call of duty, qualified by the successful completion of any secondary or tertiary objectives a mission may call for, shall commend a MechWarrior with the highest honor of the Clan.
- By fighting a war with fewer combatants, fewer lives are lost. Engaging in battle with the fewest 'Mechs possible, in the tradition of the *Batchall*, shall uphold a warrior with the highest honor of battle.
- Deploying lighter 'Mechs into combat than the Keshik deems necessary and preserving the technology of the Clans shall give a MechWarrior much honor through his career.
- Engaging in battle with more than one 'Mech against a sole MechWarrior holds the least honor; one-on-one combat holds the highest Clan honor.
- A MechWarrior commanding a Star is held responsible for his starmates. The loss of a starmate is deemed a dishonored act in the tradition of Clan warfare and shall be noted.
- Engaging in battle under the condition of Altered Reality, which causes a pilot to battle under the false belief of **Invulnerability** or **Unlimited Ammo**, shall deny a MechWarrior's advancement through his career.
- Knowingly piloting a 'Mech whose **Heat Tracking** and **Collision Damage** system have been altered shall earn a MechWarrior great dishonor.



PRE-LAUNCH PROTOCOL

MISSION BRIEFING

Upon reporting to the **READY ROOM**, each MechWarrior will receive a detailed **MISSION BRIEFING** in the form of an incoming coded message from the Keshik prior to launching a mission. The **MISSION BRIEFING** will describe the mission instructions, the objectives of the mission and a situational report of the ongoing conflict.

CAPTURE AND
SECURE —
THEN
DEFEND

MISSION TYPES

The Keshik's mission instructions will follow combat procedures for one of the five mission types to which a MechWarrior can be commissioned to: (1) Strike (2) Defend (3) Escort (4) Combat Patrol, or (5) Reconnaissance. Each mission will call for the exceptional piloting of a BattleMech with the correct combination of stealth, speed and a decisive mix of weaponry and firepower that is tailored to the type of mission at hand. Refer to "BattleMech Selection" in this section for strategic advice on effective use of BattleMech resources.

MISSION OBJECTIVES

Each combat mission is preceded by a mission briefing that details the objectives of the combat scenario a MechWarrior is about to embark on. Most missions consist of multiple objectives that create the focus of a mission, encompassing not only one or several **Primary Objectives** (which are the mandatory objectives of the mission), but also secondary and often tertiary objectives.

A BattleMech pilot's precise understanding of the objectives of an assignment will prove beneficial to his career. The **Primary Objectives** of a mission convey the minimal accomplishments a MechWarrior is expected to achieve for the mission to be deemed a success. The completion of any secondary and/or tertiary objectives will warrant honor and glory above and beyond that of an honorable victory.

PRIMARY
CHECK SUMMARY!
FIZ

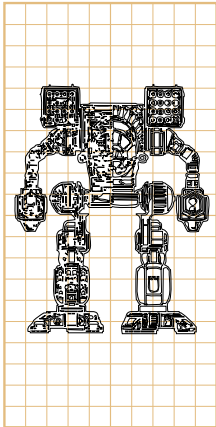

In addition to the **Primary Objectives** of a mission, Mechwarriors are often required to destroy **Targets of Opportunity** that may appear during a mission. These targets consist of enemy objects which are not explicitly described in the mission briefing, but are nonetheless viable targets whose destruction will hamper the enemy's war machine.

Various conflict scenarios also require a MechWarrior to meet an additional **Return Condition** before the mission can be declared officially over. This requires a MechWarrior to pilot his 'Mech to a pre-determined destination for a dropship departure or a "dust-off" extraction. This condition promotes the preservation of technology, by allowing the Clans to confirm the integrity of the deployed BattleMech and lessening the risk of enemy-captured 'Mech technology.

SITUATIONAL REPORT

MechWarriors are advised to review the situational report section of each mission briefing for a broader understanding of the state of affairs that may affect the battle scenario. The situational report expands on the mission objectives relating them to the global political unrest within the Universe.

BATTLEMECH SELECTION

The Keshik will advise a MechWarrior on the suitable BattleMech technology for each assigned mission. However, a MechWarrior is entitled to review available Clan technology within applicable weight limitations set by the Keshik and select an alternate 'Mech according to a pilot's preference.

'MECH TYPES

The modern BattleMech is perhaps the most complex machine ever produced. Incorporating complex methodologies to create war machines with different areas of superiority, BattleMech technology has succeeded in developing a reserve of BattleMech models with varying battle advantages.

By exploring the unique capabilities of each BattleMech, MechWarriors can evaluate a 'Mech's strengths and weaknesses in the areas of size, weight, speed, firepower, maneuverability and stealth. This aids a MechWarrior in tailoring the deployment of a 'Mech to



the specific objectives and environmental conditions of a mission. For example, a common deployment tactic is using a lightweight class 'Mech for reconnaissance missions since they are known for being highly efficient in expeditious inspections of enemy territories, yet not heavily armored.

Refer to **Appendix D — Diagrams of the BattleMechs** for configuration specifics on Clan technology.

■ Firemoth

Trading armor for a top speed of 162 kph, the 20-ton Firemoth is the fastest Clan 'Mech in existence. Known for its ability to pack a powerful punch against 'Mechs up to 10-15 tons heavier, its light weight and notable speed makes it an excellent machine for recon patrol or scouting.

■ Kitfox

At 30 tons and topping out at 100 kph, the Kitfox is clearly a fast combat machine. With a greater space for weaponry and equipment, the Kitfox offers a better spread of weapons and stronger armor, making it a popular 'Mech for training and a wise selection for newer pilots.

■ Jenner II-C

At 35 tons, the lightweight Jenner II-C boasts additional missile packs and a top speed of 150 kph — a considerable improvement on the Inner Sphere Jenner. Recognized as a fast-moving missile boat, this Clan renovation is dangerously ammo-dependent and takes the risk of becoming an unfortunate observer.

■ Nova

As the first 'Mech in the medium-weight line-up equipped with jump jet capability, the Nova is recognized for its agility in getting out of tight spots. At 50 tons and extensive firepower for its size, the Nova has proven effective in patrol or defense missions.



TOPSO-TWIST
OR DIE!

TRY JENNER
VARIANT
W/ ONLY
ENERGY WEAPONS



WHEN IN
DOUBT...STORM

■ Stormcrow

The Stormcrow offers 55 tons of solid combat power. With a potent spread of weapons, substantial speed and strong armor values, the Stormcrow is a well-balanced all-around 'Mech capable of completing most combat objectives effectively.



■ Mad Dog

A solid medium-weight 'Mech, the Mad Dog displays a solid mix of weapons for its 60 tons of fighting metal. Widely utilized for its long-range firepower, the Mad Dog is capable of giving a serious punch and is tough enough to take one.

■ Hellbringer

The Hellbringer boasts a good spread of weapons across the board. At 65 tons, the Hellbringer is a fast, tough, all-around 'Mech that is exceptionally effectual in close-range battle and defensive missions.

■ Rifleman II-C

This 65-ton Inner Sphere retrofit benefits from the addition of pulse lasers and jump jets. Though a tough contender, the Rifleman II-C is slow and often forces pilots to employ jump jets for escaping an attack rather than lateral movement. It is noted for its deftness in defense and combat patrol.

*HEAVY
FIREPOWER
BUT ↑ HEAT

■ Summoner

At 70 tons and equipped with jump jets, the primary configuration of the Summoner is one of the heavier 'Mechs with jump capability. The Summoner is popular for its invaluable combination of speed, weaponry and jump capacity.

ALWAYS
ENGAGE
IN THE
FLANK

■ Timberwolf

This 75-ton machine is favored by Clan Wolf for its incredible versatility and ability to take a serious pounding. A popular reverse-joint 'Mech or "chicken-walker," the Timberwolf is equipped with one of almost every type of weapon and is commonly used by Clan commanders.

■ Gargoyle

The Gargoyle packs its 80 tons with powerful firepower; however its weapons are highly ammo-intensive and demand a pilot's constant gauging of depleted ammo. A superior close-range 'Mech, the Gargoyle is often employed for urban fighting and civil unrest.

■ Warhammer II-C

This 80-ton heavy 'Mech retrofit is a popular deployment amongst the Clans. Well-known for its durability and its even spread of weapons, the Warhammer II-C is capable of enduring extensive combat patrol and strike missions while inflicting a considerable amount of damage.

■ Warhawk

This 85-ton assault 'Mech carries a 10-missile pack that can pepper an enemy from distances unreachable by most enemy opponents. With four particle projectile cannons that can be fired in one fell swoop, this 'Mech is highly regarded for its intense mix of firepower.

JUMP JETS ←
KEY TO
SURVIVAL.

■ Marauder II-C

Much like the Inner Sphere variant, the 85-ton Marauder II-C is equipped with a host of lasers and PPCs, making it a fierce close-range and defense opponent. With a maximum speed of 64.8 kph, the Marauder II-C is often highly regarded for its phenomenal endurance in combat.

■ Dire Wolf

Weighing 100 tons, the Dire Wolf is the heaviest of the Clan 'Mechs. It carries a large amount of weaponry that allows it to take a major beating before an imminent breakdown. However, due to the frontal location of its cockpit and speed that's hindered by its immense mass, the Dire Wolf can quickly become an easy target for faster 'Mechs.

TRY FOR
HEAD
SHOT VS.
DIRE!

BATTLEMECH COMPONENTS

The internal structure of a BattleMech is composed of eight sections: Head, Center Torso, Left and Right Torso, Left and Right Arms, and Left and Right Legs. Each of these sections serves as a designated area for carrying weapons, ammunition or additional equipment in a BattleMech. The following are the systems that comprise a BattleMech:

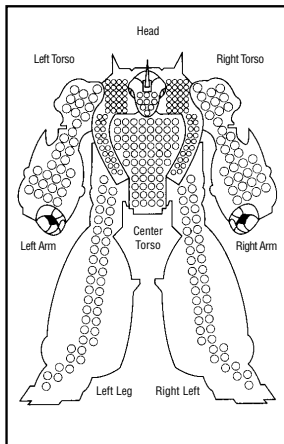

■ Engines

BattleMechs can be equipped with a wide variety of engines to determine maximum land speed. There are two types of engines: standard or XL engines. The XL engines are retrofit standard engines with new and lighter shielding materials, greatly reducing overall engine weight at the cost of compactness. Although normal engine weight is halved, additional engine critical space must be allocated to both the Right and Left Torsos.

■ Cockpit/Gyroscope

Every BattleMech includes a cockpit containing the MechWarrior's control station, life-support system and electronic sensors. Damage to a 'Mech's control components impacts its ability to move and jump. In addition to a cockpit, every BattleMech is equipped with a powerful gyroscope to keep it upright and able to move.

■ Internal Structure

Internal structure is the backbone of the 'Mech. A BattleMech's internal structure can be designed in using one of two Clan technologies: standard or Endo Steel. Made with zero-G manufacturing techniques that mix high-density steel with lower-density titanium and aluminum, Endo Steel is twice as strong per unit of weight as standard materials. However, strength is traded at an increase in overall bulk requiring more critical space in a 'Mech's internal structure.

■ Heat Sinks

Heat sinks supply a BattleMech with the ability to dissipate heat internally. Double heat sinks can cool a 'Mech much more efficiently with a heat-dissipation rate that is twice as fast as that of standard heat sinks. Although double sinks weigh the same as standard heat sinks, the double versions are considerably bulkier and take up extra space aboard a 'Mech. At one ton and two critical slots each, Torso-mounted double sinks

* WATCH
HEAT
LEVELS!

tend to limit space for weapons. Refer to "Heat Management, under "Basic Piloting" in the **Combat Protocol** section.

■ Jump Jets

Most 'Mechs can be equipped with jump jets located in pods in the Leg and Torso areas to allow jump movement. Jump jets may only be mounted if there are sufficient critical slots in these areas. To gain desired jump capacity, a MechWarrior must evaluate the environmental conditions of the mission as well as the overall mass of the 'Mech being customized before determining the number of jump jets being added.

■ Armor

A BattleMech's armor provides the protective covering for its internal structure and critical components. There are two types of armor a pilot can choose to assign to a BattleMech: normal or Ferro-Fibrous armor. Ferro-Fibrous armor is an improved version of the ordinary BattleMech armor in that it greatly increases a 'Mech's tensile strength. Although this advanced armor gives a 'Mech a greater armor factor for the same weight, it is bulkier than its equivalent weight of standard armor plating and requires more critical space in a 'Mech's internal structure.

■ Weapons Systems

Pilots can equip their 'Mechs with any mix of weapons their assigned base chassis will support. MechWarriors must weigh the advantages of using different energy, missile or ballistic weapons systems against the weight and space considerations of all possible combinations. Some weapons systems are more powerful at the expense of greater heat buildup, while other weapons cause less damage but have greater distance advantages. Refer to "Weaponry" in the **Combat Protocol** section.

■ Ammunition

All weapons other than energy weapons (e.g., lasers) require a pre-allocated supply of ammunition that can be determined by each pilot. Ammo must also be allocated to critical slots within a 'Mech's internal structure.

JETS USEFUL
IF
LEG IS LOST

BALANCE WEAP.
- HEAT BUILDUP
- CYCLE TIME
(recharge)
- LIMITED
AMMO
- RANGE

← JETTISON
TO PREVENT
EXPLOSION
[K]

■ Equipment

Every BattleMech is equipped with **CASE** (Cellular Ammunition Storage Equipment), a damage-control technology that mitigates the effects of internal ammunition explosions. When ammo explodes in a location with CASE, the force of the explosion is directed away from the 'Mech's vital components, such as the cockpit or the engine.

A pilot can choose to equip his 'Mech with **MASC**, enabling the capability of short bursts of speed. Refer to "MASC" under "Advanced Piloting" in the **Combat Protocol** section.

■ Criticals

All components housed within a BattleMech must be assigned to **critical slots** within a 'Mech's internal structure. The number of available critical slots in each section of a 'Mech's base chassis limits the mix of weapons and equipment with which any particular 'Mech can be configured. The construction of a BattleMech cannot be completed until each item has been assigned to the requisite number of critical slots.

BALANCING A 'MECH

The **'MECH LAB** allows BattleMech pilots to customize their 'Mechs with any legal mix of speed, armor, weaponry and equipment. The 'Mech Design Lab is accessible to experienced MechWarriors who opt for battle in customized BattleMechs or to pilots who wish to redesign their assigned 'Mechs.

'Mech construction consists of adding components to a standard chassis while maintaining a workable balance of BattleMech current mass and available critical space. Any design involves weighing the advantage of one capability over another. For example, a 'Mech can be constructed with extensive firepower, but the extra weight will make for a slow design. Refer to **Appendix B — Procedures for Customizing a BattleMech**.



STAR CONFIGURATION

The organization of 'Mechs on the battlefield is based on a squadron of 'Mechs – the Star. A Star can include up to three members, with one member being the designated leader and commander of the Star. After each mission briefing, a MechWarrior is advised to consult the **STAR CONFIGURATION** Holoprojector to review the recommended 'Mech deployment. Here a MechWarrior can access information on the total mass, the maximum mass per 'Mech and the maximum number of Star points the Keshik has assigned to the mission.

At this point, pilots can choose to add or delete starmates (up to the Keshik's maximum deployment recommendation) and launch the mission with a larger or smaller Star. Once the size of the Star is determined, a Star commander can re-select a base chassis for himself or his starmate(s) – or customize the existing 'Mech configurations for the entire Star while staying within the limits set by the Keshik on the size of the Star and the maximum weight of each 'Mech.

MechWarriors can also reassign the positions of their Star unit's BattleMechs to one of six different Star formations before each mission. All starmates will begin in formation awaiting orders at the beginning of each mission. Star formations can also be changed during a mission after launch has taken place in response to enemy activity. A strategic reformation of a Star could determine a Star unit's victory or defeat.

Re-configuration of a Star is most effectively implemented once a MechWarrior has determined the direction from which impending enemy threats are detected. MechWarriors must be prepared to assign Star configurations in response to the assumed tactical stance of each mission (i.e., offensive, defensive or reconnaissance), as well as to the situational conditions of combat.

In order to easily identify starmates while in battle, a Star commander can reassign his starmates' **Callsigns** by selecting the name above each starmate in the **Star Configuration** Holoprojector.



DIRECTION OF TRAVEL



TACTICAL STAR FORMATIONS

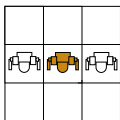

■ Line Abreast

This side-by-side formation is useful in bringing an entire unit's weapons to bear on enemies positioned directly in the frontline of travel. It promotes accuracy in usage of weapons systems without a need for complex 'Mech handling or navigation.

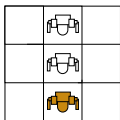

■ Line Astern

This configuration assigns 'Mechs to a single-file formation recommended for strike missions heading straight into heavily concentrated enemy territories. The Line Astern formation is highly effective during enemy ambushes heading perpendicular to the Star, or if an enemy attack from the sides is highly probable.

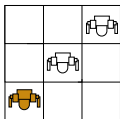

■ Eschelon Left

This diagonal Star formation leads its wingmen at a 45-degree left-angle. Useful when an enemy threat is positioned forward and to the left, this configuration ensures protection while allowing an open line of fire for efficient weapons usage.

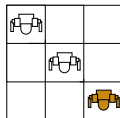

■ Eschelon Right

The alternate diagonal Star formation leads its wingmen forward and to the right at a 45-degree angle, providing a clear angle of fire while allowing protection of the flanks. This configuration is most effective when the enemy is believed to be approaching from a forward-right direction, employing wing men as guards.

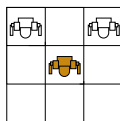

■ Wedge

This Star formation, regarded highly honorable, allows the Star commander to tactically divide an enemy formation with maximum backup. Such a Star configuration maneuver is dangerous, yet recommended in scenarios involving heavy reconnaissance and minimal defensive action.

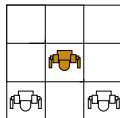

■ V-Formation

This all-purpose Star formation allows a Star commander to direct a Star from the rear. It offers a highly practiced technique for surrounding an enemy while providing maximum cover from the front to secure a Star commander's position.

COCKPIT CONTROLS

This pre-launch preparation area allows a pilot to customize and configure his 'Mech's peripheral control systems to his own specific preferences. The Keshik will supply a recommended configuration (default) for each pilot prior to launch. Refer to **Appendix A — Default Control Configuration Systems**.

COMBAT VARIABLES

DIFFICULTY

A MechWarrior's reliance on a 'Mech's targeting computer to detect weaknesses in the enemy affects the difficulty factor of each mission: **Easy, Medium, or Hard**. If a MechWarrior requires heavy assistance from the enhanced on-board system (Easy), he will have limited use of true piloting skills — thereby receiving less honor for the victory. A MechWarrior shall be revered with greater honor and glory for accepting missions with minimal use of the on-board targeting computer (Hard).

The difficulty of a mission is also greatly impacted by a pilot's ability to manage his 'Mech's heat. A pilot can choose to pilot with a 'Mech's **Heat Tracking** system ON or OFF. However, relying on a 'Mech's Heat Tracking computer, rather than the manual implementation of this vital system is dishonorable. A MechWarrior will receive no honor for a mission which is undertaken without the proper use of its **Heat Tracking** system.

AUDIO

MechWarriors can control the audio frequencies to be received while inside the cockpit before launching into a mission. A slider bar can be utilized to adjust the volume of all incoming audio, including on-board computer messages.

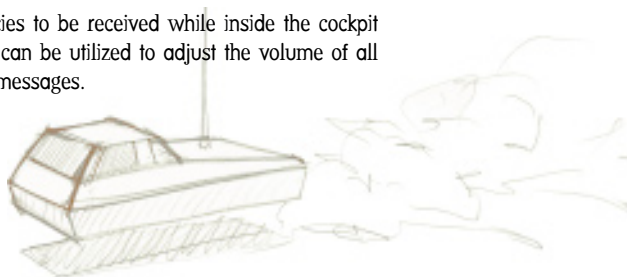

DETAIL

A Mech's **Detail** control panel allows a MechWarrior to activate unique in-cockpit visual systems before a mission begins. MechWarriors wishing to increase (PC) system performance should de-activate these **Detail** functions (toggle to OFF or Low):

Object Textures	(ON/OFF)	Changes the textured surfaces on all man-made objects.
Terrain Textures	(ON/OFF)	Affects the texturing of most natural formations in the environment.
Display Detail	(High/Low)	Affects the level of detail of all objects within the world.
Object Density	(High/Low)	Sets the density of objects within the world.
Chunky Explosions	(ON/OFF)	Determines the amount of debris generated when objects are destroyed.
Resolution		Sets the resolution of the display: 320 x 200, 640 x 480, or 1024 x 768. (Some settings may not work with certain graphics cards.)

ALTERED REALITY

There have been many reports made by MechWarriors claiming the temporary invincibility of their BattleMechs while on the battlefield. Scientists have described this rare occurrence of altered reality as a delusional condition caused by a warrior's deep state of euphoria.

Invulnerability	OFF/ON (Dishonorable)
Unlimited Ammo	OFF/ON (Dishonorable)
No Collision Damage	OFF/ON (Dishonorable)

IMPORTANT: Should a MechWarrior willingly experience an altered state of reality within his combat experiences, the Keshik will assuredly deny him the right to progress in his career.



LAUNCH

Upon accepting the conditions of a mission, a MechWarrior and his BattleMech are transported to the pre-determined battle site via dropship along with his starmates. Many times the dropship will hover on the planet where the engagement is to take place, while other times a hostile environment will require the dropship to return for a fast pickup once the mission has ended. All arrangements for dropship pick-up and drop-off are detailed in the **Mission Briefing**. A pilot can review this information anytime after LAUNCH by consulting the **Objectives/Briefing Summary**.



DEBRIEFING

Each debriefing supplies MechWarriors with an in-depth report of their performance in battle. Each mission debriefing determines whether the previous engagement was a success or a failure, listing the mission statistics that communicate either the honorable or dishonorable feats of battle. Upon succeeding in a mission, the debriefing will describe the positive effects of completing the mission objectives as well as any universal issues related to a MechWarrior's achievements. At this time, a MechWarrior will also receive any advances in Clan rank that may be merited.

If, however, a MechWarrior has failed a mission, he will be informed of the detrimental effects of his failure and offered the opportunity to regain his honor by re-attempting to perform the objectives of the failed mission. A MechWarrior can choose to accept or deny this offer, although denying will prohibit a MechWarrior's ability to advance in rank and progress through his career.

THE ROSHAK
MANEUVER
(circle of death)
2 STARS CIRCLE
AT 90°
TOPSO TWIST
↓
ALL FIRING
INWARD
(Battle of
Pasadhuque)



COMBAT PROTOCOL

BASIC PILOTING

Effective piloting involves the effective usage of basic in-cockpit systems and the careful analysis of the mission objectives and planetary environment. Mastering the essentials of piloting a BattleMech is the first step towards rapid career advancement.

HEAT MANAGEMENT

Internal heat buildup is one of most severe problems a BattleMech will encounter during combat. A BattleMech builds up heat whenever it moves or fires its weapons or stands in an area of intense heat. With heat sinks being its single method of dissipating heat, a pilot's overactivity (i.e., over-use of weapons) or outside air temperatures may produce more heat than a BattleMech can dissipate.

If its internal heat reaches critical heat levels, the ammunition or other systems that it carries may cause an internal thermal explosion. To avoid such catastrophic damage to vital Clan technology, BattleMechs are designed to automatically shut down when a 'Mech's ammo threshold has exceeded maximum critical levels. This forces a BattleMech to remain inactive until heat is reduced below critical levels. BattleMech pilots are able to manually **Override Automatic Shutdowns** to get the benefit of their weapons systems and avoid shutdowns during critical situations. This is a strategic maneuver that must be utilized with great caution. However, a pilot should beware reaching full **RED** levels on his **Heat Tracking Indicator** once the automatic shutdown has been overridden. If the Indicator reaches a full-state of **RED**, the 'Mech is at risk of having a fatal internal ammo explosion due to excessive heat levels.

WARNING:
DO NOT
EXCEED FULL
RED

* CYCLE TO
MACHINE GUNS
AT CRITICAL
HEAT LEVELS!
DON'T
PRODUCE HEAT

HANDLY
OVERRIDE
AUTOMATIC
SHUTDOWN
□

NEURAL-IMPULSE CONTROL

The basic element of a 'Mech's control system is the neural-impulse helmet. These bulky neurohelmets normally cover a MechWarrior's entire head, attaching firmly to the shoulders of a pilot's cooling vest. Electrodes on the interior of the neurohelmet channel sensory information from the BattleMech directly to the pilot, converting raw data on posture, movement, balance and speed into neural impulses for the human brain. At the same time, the helmet and its linked computer translate impulses from the MechWarrior's brain into signals transmitted directly to the 'Mech's gyroscope and myomer musculature. In this way, the reflexive bodily movements of the BattleMech are controlled subconsciously by the pilot, leaving his conscious brain free to control the various weapons and other systems as needed.

THROTTLE

The throttle controls the amount of power supplied to a BattleMech engine. It determines BattleMech speed just as the gas pedal once determined an automobile's speed in the 24th century. The throttle can be directly shifted to incremental speeds, measuring from a complete stop at one (1); half throttle at five (5); and 100% power at zero (0) on a 'Mech's **Throttle Indicator** in the cockpit control panel. The throttle can be incrementally adjusted as well. Running at full throttle is not without consequence. The higher the percentage of throttle at which a MechWarrior chooses to power his BattleMech, the higher the propensity of heat buildup and the risk of an internal ammo explosion.

A MechWarrior can also use the throttle to drive a BattleMech in reverse. The maximum capable reverse speed of a 'Mech is 50% of a 'Mech's maximum throttle forward. The reverse throttle has proven an invaluable last-resort maneuver for pilots with no other choice but to evade enemy fire when in close quarters. Refer to the **HUD** for location of the **Rear View** camera on a Mech's **Multi-Function Display** to aid in steering in reverse.



STEERING

TURN LEFT
↑ RIGHT =
← →
ARROW KEYS

The basic maneuvering of a 'Mech depends on a MechWarrior's ability to steer under the varied conditions of combat. Steering a 'Mech effectively requires a continual assessment of the world's surroundings and an appropriation of throttle control and speed consistent with the environmental conditions observed. It is important to note that extensive damage to a 'Mech's internal structure may result from a collision between two objects traveling at high speeds.

Turning a BattleMech also requires a careful calculation of the present situation. Since the radius of a turn is directly related to the speed at which a BattleMech is traveling, the recommended procedure for executing a quick turn in a 'Mech is to throttle down prior to initiating the turn.

TORSO TWIST
← →
RECENTER
TORSO TO LEGS
✓

TORSO TWIST

With the exception of the Nova, all BattleMechs are capable of Torso movement of up to 90 degrees to the left, or to the right of center, which allows for travelling in one direction while engaging the enemy on his flank. The timing and coordination of a torso move are vital in making such a practice an effective combat maneuver. The current measure of **Torso Twist** is indicated by a **GREEN** bar above the **Heading Indicator** in the **HUD**.

PILOT EYE
CONTROL
COCKPIT
ZOOM IN
CTRL Z
+
ARROWS
COCKPIT
ZOOM OUT
SHIFT + Z

PILOT EYE CONTROL

Pilots can look Left, Right, Up or Down from inside their cockpits to get a better view of their surroundings without having to turn either their 'Mechs or their torsos. The pilot can either glance in a particular direction or reorient himself to face a different direction. Utilizing these views is effective in spotting an enemy threat not in a MechWarrior's direct line of fire.

A pilot can also choose to **Zoom In** or **Out** from any of these interior cockpit views for a closer or wider view of the area by using the optical magnification system.

EXTERNAL
TRACKING
CAMERA
(XTC)
C

EXTERNAL TRACKING CAMERA (XTC)

Electrodes on the interior of a pilot's neurohelmet allow MechWarriors to access an over-the-shoulder tracking view of their piloted 'Mech, offering a third-person perspective of the ensuing conflict and their vehicle.

SATELLITE UPLINK

The **Satellite Uplink** supplies a MechWarrior with a bird's-eye view of the area as viewed from a geosynchronous observation point one kilometer overhead. This wire-frame representation of the satellite view is beamed into a pilot's neurohelmet. A pilot can increase the **Satellite Uplink** scaling factor to see a more detailed representation of an area, or decrease the scaling factor to cover a larger radius of the overhead view.

LOW-LIGHT AMPLIFICATION

This enhanced-vision system aids a BattleMech pilot's visual ability in dark, low-light or dense atmospheric environments hindering clear vision. During night battles or when visibility is low, a pilot can rely on this infrared system's sensors to project enhanced images of the otherwise indistinguishable environment.

SATELLITE UPLINK
[F3]
SATELLITE UPLINK
ZOOM IN = [X]
ZOOM OUT
= [SHIFT] + [X]
[LOW-LIGHT AMPLIFICATION ON/OFF] [D]

HEADS-UP DISPLAY SYSTEMS (HUD)

These displays are projected directly onto a pilot's retina via his neurohelmet and are superimposed over the pilot's normal view of the world. These systems can be damaged or rendered inoperable from critical hits to system sensors.

CYCLE THROUGH HEADS UP DISPLAYS [F1]

DISABLE HUD = [F11]
RADAR DISPLAY (1/4 SCREEN / FULL SCREEN)
[F2]

■ Radar System

The radar display supplies a MechWarrior with remote detection intelligence represented by color-coded blips. It detects the presence of enemy threats and reveals the position of friendly 'Mechs within a one kilometer (default) radius of a pilot's BattleMech. The radar display shows all enemy information in **RED**, friendly information in **GREEN**, any neutral data in **BLUE** and NAV points in **YELLOW**. The "V" indicates the resulting field of view based on the angle of the 'Mech's Torso.

Activating the **Zoom** function of the radar screen increases the level of detail in the radar display while decreasing the overall range from 500 kilometers to 2.0 kilometers. Pilots can also choose to toggle between the standard size radar display to a full-screen radar mode that appears as an overlay centered around a BattleMech's crosshairs. A BattleMech's radar system also designates a pilot's currently targeted enemy by shifting its blip representation to a bracketed or highlighted one. Refer to "Targeting" in the **Combat Protocol** section. Also

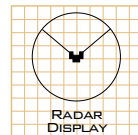

detected on the radar display is the currently targeted NAV point. Refer to “NAV Points” under “Navigation” in this section.

■ Heading Indicator

This directional indicator shows a pilot his 'Mech's heading in degrees, with zero indicating due North. **RED** arrows will appear on the indicator to show the direction to the targeted object, and a **GREEN** bar above this indicator will relate the degree of a torso twist.

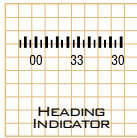

■ Weapons Display

The **Weapons Display** shows all weapons carried by a BattleMech on the upper right-hand corner of the **Heads-Up Display** with an outline indicating the currently selected weapon. Note: Any weapon rendered inoperable by a critical hit will appear in **RED**. The default displays all weapons in a single group arranged by the 'Mech's left- and right-side assignments. The **Weapons Display** also indicates the grouping of up to three distinct weapons groups designated by the colors: **GREEN**, **WHITE** and **YELLOW**. Refer to “Weaponry” in this section for procedures on “Grouping Weapons.”

■ Altimeter

The **Altimeter** on the left-hand side of the pilot's console measures a BattleMech's current elevation from the horizon in meters. With a **YELLOW** tick at zero designating sea level and a **BLUE** tick marking the current ground level beneath a 'Mech, a MechWarrior can always determine his 'Mech's current altitude. The altitude of a targeted object is marked by a small **RED** arrow. The altimeter is especially useful when considering the atmospheric effects of navigating over mountainous areas or while using jump jets.

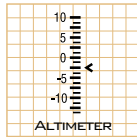

■ Throttle Indicator

This **HUD** indicator measures the current throttle power used by a BattleMech – with **GREEN** indicating forward throttle power and **BLUE** indicating reverse throttle. To the left of the **Throttle Indicator** a small read-out will display the 'Mech's current speed in kilometers per hour, indicating negative kilometers per hour for reverse throttle movement.

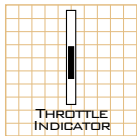

■ Targeting Reticle

The **Targeting Reticle** indicates the object upon which a pilot's weapons are being focused. The reticle appears in **GREEN** to indicate a weapon is armed and ready to fire, while a **YELLOW** reticle indicates the weapons system's current state of recharging (e.g., loading energy weapons). A **RED** targeting reticle confirms that the object is within range of the selected weapon and is approximately on-target or in the case of homing weapons, that the targeting computer has acquired a lock. Refer to "Targeting" in the Combat Protocol section.

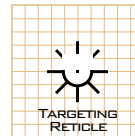

■ Targeting Brackets and Markers

When an object is targeted, targeting brackets will appear around the object to mark a 'Mech's current target. The brackets will appear in **GREEN** to indicate a friendly object; **RED** to mark an enemy object; and **BLUE** for any targeted object with a neutral affiliation (e.g., non-enemy structures).

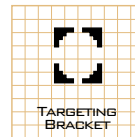

A **RED Targeting Marker** appears on the **Heading Indicator** to show the relative direction of the current target; the marker on the **Altimeter** marks its current elevation.

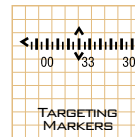

■ Targeting Camera

The **Targeting Camera** screen identifies the targeted object, showing its current actions and its orientation to the pilot's 'Mech. The **Targeting Camera** can be toggled to display its data in detailed photographic images or wire-frame to display a targeted object's current damage. The wire-frame display will indicate damage in three colors: **GREEN** = No/Superficial Damage; **YELLOW** = Moderate; **RED** = Critical Damage; **BLACK** = Maximum Damage. Refer to "Target View" under "Targeting" in this section.

TARGETING

F4

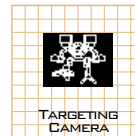

■ Targeting Information

When an object or NAV point is targeted, a 'Mech's targeting system identifies the targeted object's name and its current range in meters. This targeting information appears at the bottom-left side of the **HUD** (below the **Targeting Camera** display screen if enabled). A pilot can also access further targeting information about many objects by activating the **Inspection** command.

ALWAYS WAIT
FOR MISILE LOCK
BEFORE FIRING

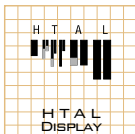
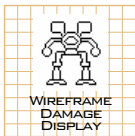
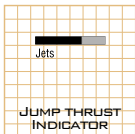
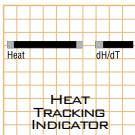
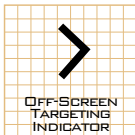

■ Off-Screen Targeting Indicator

If a targeted object advances past a pilot's visual range, an **Off-Screen Targeting Indicator** will alert the pilot of the relative heading of the target. This indicator appears in the form of a **RED** arrow along the perimeter of a pilot's **HUD** to indicate a targeted object. This off-screen target information also appears in a scaled-down display on the radar screen.

■ Heat Tracking Indicator

This heat indicator measures a 'Mech's heat buildup and dissipation. It tracks heat in three measures: **BLUE** = Nominal Heat; **YELLOW** = Marginal Heat; and **RED** = Critical Heat. The **DeltaHeat Indicator** constantly surveys a BattleMech's current rate of change in heat buildup.

■ Jump Thrust Indicator (JTI)

The **JTI** will be displayed on the **HUD** of BattleMechs equipped with jump jet capability. This indicator measures the remaining amount of charge in a 'Mech's jump jets.

■ Multi-Function Display (MFD)

This **HUD** is automatically initiated at launch. Pilots can toggle from the **Wire-Frame Damage Display** (default) to a more specific damage display or several optional camera views:

■ Wire-Frame Damage Display

Upon activation, this system displays a color-coded representation of the 'Mech's damage: **BLUE** = No/Superficial Damage; **YELLOW** = Moderate Damage; **RED** = Critical Damage; and **BLACK** = Maximum Damage.

NOTE: 'Mech sections appearing in **BLACK** indicate systems that have been severed or rendered inoperable.

■ HTAL (Head Torso Arm Leg) Damage Report

This detailed display shows section-specific damage information of the piloted 'Mech's structure and remaining armor for that area (marked in **GREEN**). A bar measures damage to each corresponding section: Head, Torso, Arms, Legs — with Torso being broken up into Left, Center and Right, each having a separate front and back section.

'MECH DAMAGE
F5

DETAILED
AND
ACCURATE

■ Rear View

The **Rear View** camera can be activated to display a behind-the-Mech exterior view to get a handle on what's going on behind.

■ Down View

The **Down View** camera captures a lower view from directly beneath the Mech – useful during jump jetting, especially while attempting **DFA**. Refer to "Jump Jetting" under "Advanced Piloting" in this section for **DFA** procedures.

■ Weapon View

The **Weapon View** camera can be activated upon firing off a weapon to track its path until it reaches its target. A pilot can also activate a full-screen **Weapon View** once a salvo of missiles has been launched to track its progress.

■ Systems Status

This unique BattleMech computer monitors several advanced systems that are accessible to a MechWarrior during battle through a single key on his console:

Low-Light Amplification	ON/OFF
Enhanced Imaging	ON/OFF
Head's-Up Display	ON/OFF
Pilot Auto-Ejection	ON/OFF

■ Objectives/Briefing Summary

A pilot can access a short-form report of the primary, secondary and tertiary objectives that have been assigned for the mission once it has commenced. This updated mission briefing supplies a MechWarrior with a quick recap of all completed mission objectives as well as the status of all current objectives.

REAR VIEW
[F7]
DOWN VIEW
[F8]
WEAPON VIEW
[F9]
WEAPONS
(full screen)
[F10]

SYSTEMS
STATUS
[U]

OBJECTIVES/
BRIEFING
SUMMARY
[F12]



BATTLE PARAMETERS

BATTLE
PARAMETERS/
QUIT

ESC

ABORT MISSION

Though considered a failed battle, a MechWarrior can opt to renege on an accepted mission once out on the battlefield. The Keshik disapproves of wasteful deployment and reviews the career of the pilot in question accordingly.

DEVICE CALIBRATION

This system allows a pilot to calibrate various cockpit control systems that may require re-alignment, including input devices as well as monitor brightness. Refer to **Appendix A – Default Control Configuration Systems**.

EXIT
MECHWARRIOR 2
TO
DOS

ALT + ESC

AUDIO CONTROL

Once a combat mission has been accepted, a pilot can choose to re-adjust the volume of all incoming audio: sound effects, in-cockpit communications and music.

COMBAT VARIABLES (PERFORMANCE SETTINGS)

This visual detail control panel allows pilots to re-activate in-cockpit visual systems after a mission has been launched. These options may affect a pilot's combat speed and performance (on certain PC systems) and should be set accordingly:

Object Textures	ON/OFF
Terrain Textures	ON/OFF
Display Detail	Low/High
Object Density	Low/High
Chunky Explosions	ON/OFF

NOTE: Pilots are able to record still images of the unfolding conflicts by activating a .GIF camera during the mission (to take a screenshot of the sim). Files will be named MW2*.GIF and saved in the Main Game Directory.

.GIF CAMERA

CTRL + P



DESERTING THE BATTLEFIELD (FLEE TO DOS)

Many warriors have been known to engage in such dishonored behavior when all else is lost. The Keshik justly records all bouts of weakness exhibited by pilots.

NAVIGATION

Efficient navigation of a BattleMech requires a MechWarrior's expeditious and orderly completion of a mission's predetermined navigational sequence. Each **NAV sequence** is mapped out before each mission, supplying a MechWarrior with directional guidance to targets, structures or locations where an engagement or objective is to be met. These instructions are usually laid out in a specific sequence to be followed.

NAV POINTS

NAV points make up the navigational sequence a MechWarrior is instructed to follow. Pilots can enable a 'Mech's navigational targeting computers to receive an infrared signal of the sequence on their neurohelmet displays. The pilot can then cycle through all of the NAV points in the sequence to determine their relative locations. Once a NAV point has been targeted, a MechWarrior can access **Targeting Information** on the specific NAV point in the sequence designated by the letters of the Greek alphabet. If the targeted NAV sequence is out of radar range, the **Off-Screen Targeting Indicators** will point in the direction of the targeted NAV point. Once a NAV point has been reached, its color changes in all display screens to indicate such.

AUTOPILOT

BattleMechs are equipped with systems that automatically direct a pilot to the next unreached NAV point in a navigational sequence. A 'Mech's **Autopilot** system is useful to pilots in situations where other BattleMech systems demand a pilot's attention.



ALPHA	NU
BETA	XI
GAMMA	OMICRON
DELTA	PI
EPSILON	RHO
ZETA	SIGMA
ETA	TAU
THETA	UPSILON
IOTA	PHI
KAPPA	CHI
LAMBDA	PSI
MU	OMEGA



CYCLE THROUGH
 ALL ENEMY
 TARGETS
 [T]
 TARGET
 NEAREST
 ENEMY
 [E]
 TARGET
 FRIENDLY
 (STANDARD)
 [F]
 TARGET OBJECT
 UNDERNEATH
 RETICLE =
 [R]

TARGETING

Along with the various special targeting systems developed for streak missiles, BattleMechs are equipped with advanced targeting systems that can garner more information about the targeted object and enhance the performance of direct-fire weapons, such as lasers, PPCs, Gauss rifles and autocannons.

TARGETING INFO AND RANGES

Perhaps one of the most effective functions of a BattleMech's targeting system is its ability to determine the range of a targeted object. Upon activating a 'Mech's targeting system on a particular object, a bracket display appears around the targeted object. The targeted object is then identified by name, and its range is detected in meters. This targeting data can be accessed on the **Targeting Information** read-out for a pilot to decipher objects underneath the reticle or the nearest enemy target, or to cycle through data on all available targets one at a time.

Deciphering ranges is an important aspect of weapons management. It allows a seasoned MechWarrior to strategically expend short-, medium- and long-range weaponry, aiding in a pilot's weapons management. Refer to "Weaponry" in this section.

TARGET VIEW

Upon enabling a BattleMech's targeting system, a MechWarrior can access a visual representation of the targeted object via his **Targeting Camera**. The Targeting Camera shows the object's current bearing and its present actions in relation to a pilot's 'Mech. It can be toggled to display the targeted object in detailed photographic images or wire-frame to display a targeted object's current damage state. However, upon suffering a critical hit, a BattleMech could suffer damage to any of its camera system sensors, rendering them inoperable. Refer to "Heads-Up Display Systems (HUD)" in this section.

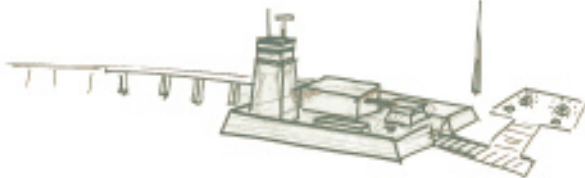

INSPECTION

Many reconnaissance missions depend greatly on a MechWarrior's skillful ability to inspect likely targets — e.g., enemy structures or foreign objects. To inspect a target, a MechWarrior must first position his 'Mech within range of the object, activate the targeting system and enable the **Inspection** computer. The **Targeting Information** system will then receive all information detailing the contents of a prospective target. If a MechWarrior attempts to inspect an object that is either out-of-range or whose contents are not relevant, the Targeting Information will display the cause of the denied inspection.

INSPECT OBJECT
↓
[I]

*GET WITHIN
RANGE -
GET CLOSE!

WEAPONRY

Weapons management is the most vital part of BattleMech piloting. Since the Clans frown upon the wasteful employment of weapons, MechWarriors must learn to use their weapons systems in the most effective yet sparing manner possible. The major distinctions MechWarriors must make when deciding on the appropriate allocation of weaponry are between ammunition-based weapons and energy weapons. Ammunition-firing weapons, like missiles and auto-cannons, always have the potential of running out of ammo. However, they generally offer the ability to reload and fire at faster rates. Although energy weapons require time to recharge in between shots and tend to build up more heat, they are highly accurate and guarantee a pilot a sure-fire weapon throughout a mission. Prior to the assignment of weapons to a BattleMech chassis, pilots are advised to research all areas of the combat mission and evaluate the effectiveness of the available weapons systems under the varying conditions of battle.

FIRE! =
[SPACE]

SELECT
WEAPON / GROUP
[ENTER]

WEAPONS SYSTEM BREAKDOWN

Consult **Appendix C — Weapons Systems** for detailed specifications of the available weapons technology.

■ Energy Weapons

■ Extended-Range Lasers

The ER laser is an upgraded Clan energy weapon with improvements that are obvious — it superior beam-focusing and targeting equipment. Although the ER laser is highly accurate for its single-laser firing mechanism, it is greatly heat-intensive.

USE LATERAL
JETTING TO
AVOID! →

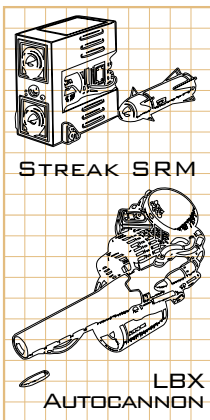

■ Pulse Lasers

The pulse laser uses a rapid-cycling, high-energy pulse to generate multiple laser beams, creating an effect comparable to machine-gun fire.

■ Extended Range Particle Projection Cannons

The extended-range PPC utilizes magnetic-field generation to form nuclear particles into a sphere that it then accelerates at a high state of energy to cause not only its target collateral damage, but great heat on impact.

■ Missiles:

■ Long-Range Missiles

The long-range missile is a specialized projectile weapon designed to make contact with its target at long range through the use of basic guidance systems.

■ Short-Range Missiles

The short-range missile's high-yield war-head supplies an accelerated burn-rate that allows it to attain a higher velocity for greater damage when fired at close range.

■ Streak Missiles

These short-range missile launchers are linked to a computerized fire-control system which handles target acquisition. Once the computer obtains a **target lock**, the streak missile will automatically home in to hit its target — barring interference from natural terrain or extreme evasive maneuvers.

■ Ballistic Weapons:

■ LB-X Autocannons

The LB-X Autocannon is a multi-speed machine-gun that fires magnetically accelerated projectiles in multiple rounds at a time. It uses special cluster munitions that fragment into several smaller submunitions when fired, improving the chances of scoring a hit and striking a critical location.

▪ Ultra Autocannons

The Ultra Autocannon features a short, smooth-bore barrel, a modified breech mechanism, a rapid-feed reloader and specially designed ammunition. Such improvements to the standard autocannon reduce minimum ranges, extend maximum ranges and permit selective fire at either normal or double rates.

▪ Gauss Rifles

The Gauss rifle uses a series of electro-magnets to propel a projectile through its barrel and towards a target. While requiring a great deal of power to operate, it generates very little heat and can achieve a muzzle velocity twice that of any conventional weapon.

▪ Machine Guns

The Clan machine gun is a rapid-fire ballistic weapon and one of the lightest, powerful weapons a BattleMech can carry. The sheer volume of shots increases the probability of scoring a hit, but does not cause severe damage to its target unless used at close ranges.

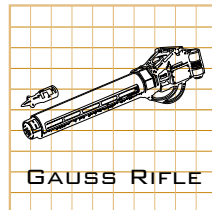

ADD WEAPON
TO GROUP 1

SHIFT + 1

ADD WEAPON
TO GROUP 2

SHIFT + 2

ADD WEAPON
TO GROUP 3

SHIFT + 3

CHAIN-FIRE/
GROUP-FIRE
TOGGLE

FIRE GROUP

1 = NUM LOCK

2 = []

3 = [X]

GROUPING WEAPONS

A Mech's default **Weapons Display** shows all weapons in a single group by the Mech's left- and right-side designations. A pilot can strategically organize his weapons in up to three groups designated by three colors: **GREEN, WHITE** or **YELLOW** on the **Weapons Display**. This allows a pilot to customize a weapons layout to suit the objectives of the mission at hand (e.g., grouping missiles in the first group allowing time for recharging while other quick-loading groups can be utilized).

CHAIN-FIRE VS. GROUP-FIRE

Pilots can configure their weapons systems to one of two different firing modes: Chain-Fire or Group-Fire. Chain-Fire mode enables the pilot to automatically advance to the next available weapon, firing each weapon within that group one at a time. Chain-Fire mode can be utilized in conjunction with weapons systems that have been grouped into a single group or multiple groups. Once grouped, a pilot can designate Group-Fire mode, enabling a MechWarrior to fire multiple weapons within a specific group simultaneously – often referred to as “weapons dump” – then automatically advance to the next group.



JETTISON AMMUNITION

A pilot is able to jettison the ammunition for a particular weapon by selecting that weapon in the firing chain and activating the **Jettison Ammunition** system in a Battle-Mech. This is a common practice in preventing internal ammo explosions in areas that have been badly damaged. It is also widely used for expelling ammo still carried for a weapon that has been lost or damaged.

DAMAGE AND CRITICAL HITS

A 'Mech can sustain damage to eight separate locations: Head, Left Torso, Center Torso, Right Torso, Left Arm, Right Arm, Left Leg and Right Leg. Each of these locations is equipped with a layer of armor that covers the internal structure and protects the contents housed inside. The Torso armor is divided into Front and Back sections. Damage to the armor of each piece is tracked in the HUD by both the **Wire-Frame Damage Display** and the **HTAL**.

Damage can be taken to a location in one of several methods: weapon impact (getting shot); proximity to an explosion (splash damage); internal ammo explosions (cookoff); and collision with another object. Once the armor in a certain section has been depleted, the 'Mech can take damage to that piece's internal structure. For each hit to the internal structure of a part, there is the chance of a critical hit.

A critical hit indicates that the equipment located within the affected section has suffered damage. Different types of equipment will react differently when delivered a critical hit:

- Weapons are rendered inoperable.
- Ammunition explodes (causing an internal ammo explosion).
- Hips, Feet, and Legs become damaged and affect movement rates.
- Jump jet exhaust ports jam — taking away the ability to jump.
- Heat sinks are lost and affect heat dissipation rates.
- Engines are damaged, decreasing the 'Mech's speed.
- Gyros break and prevent jump-jetting and affect maneuvering.
- Sensors become unreliable affecting in-cockpit systems.



- Life support systems fail — which can be fatal to the pilot in hostile environments.
- A critical hit to the cockpit kills the pilot instantly.

Some critical hits cause the 'Mech to lose the damaged part; this is known as “chunking.” The components in a chunked part are (obviously) rendered inoperable.

Internal Ammo Explosions generally cause pilot ejection (unless his system is set to **Override Auto-Ejection**). They can be triggered by both a critical hit, or excess heat levels due to a pilot overriding automatic thermal shutdown. In the case of an ammo explosion, the damage is applied to the part in which it was stored. This damage does not transfer to other adjacent locations due to the Clans' use of CASE (Cellular Ammunition Storage Equipment).

ADVANCED PILOTING

JUMP JETTING

Although jump jet technology was originally developed to give a BattleMech jump capability for access to higher ground and maneuvering, MechWarriors have refined several advanced jump jetting maneuvers that offer substantial advantages to a pilot's strategic defenses. Since a 'Mech's mass could significantly hinder its speed, jump jetting capability is reportedly used consistently by heavier 'Mechs for **Linear Acceleration** gaining great distance in shorter periods of time. Another common jump jetting practice is using jump jet capability to execute **Rapid Turning Maneuvers** that a pilot may not otherwise be able to clear; this is more widely employed by slower 'Mechs.

The most notable advanced jump jet maneuver is referred to by veteran pilots as **DFA** (Death From Above). It consists of calculated coordination of jump jet capability and steering to enact a precise landing on an enemy 'Mech's Head. Since Leg armor is stronger than average Head armor, a successful performance of **DFA** can destroy an enemy 'Mech unit on impact. This is a last-resort maneuver (i.e., to be used when ammunition is depleted or weapons have been destroyed) requiring much skill and true Clan loyalty — for in performing this maneuver, a pilot risks critical damage to his 'Mech. It is advised that any pilot attempting a **DFA** access the **Down View** camera on the **MFD** to improve accuracy.



JUMP JET
(on applicable
Mechs)
J

DFA = Viable
DEFENSE
SINCE
TUKAYID

CAUTION:
CAN BE
FITTED TO
ALM
CHASSIS

H.A.S.C. =
[V]

MANUAL
SHUTDOWN
[S]

= MANUAL
PILOT EJECT

[CTRL]
+
[ALT]
+
[E]

OVERRIDE
(OFF) FOR
A FEW USEFUL
SECS. IN
COCKPIT

ENHANCED
IMAGING
ON/OFF [W]

MASC

The Myomer Accelerator Signal Circuitry system gives a BattleMech a short-term burst of speed at some risk to its fragile leg actuators. It works by boosting the signals to the myomer musculature, causing it to contract and relax at a quicker rate than usually possible. Although this increases speed, additional stresses could cause a breakdown in the heat dissipation for the system — causing it to fail. **MASC** is an advanced system only found on the Firemoth in its primary configuration. Refer to **Appendix B — Procedures for Customizing a BattleMech** for specific procedures for equipping a BattleMech the with **MASC** system.

MANUAL SHUTDOWN

When a BattleMech reaches critical heat levels during battle, a MechWarrior can initiate a manual shutdown for a rapid method of dissipating heat and cooling a 'Mech down to a safe temperature. There have been reports of pilots using manual shutdown as a deceptive tactic on the battlefield — since BattleMechs that have initialized a shutdown sequence cannot be detected on enemy radar. This advanced piloting maneuver must be strategically timed to prove effective. Pilots can activate this same function to start up their 'Mech after manual shutdown.

PILOT AUTO-EJECTION

BattleMechs are equipped with sensors that detect imminent internal explosions. The cockpit ejection system is designed to eject a MechWarrior when a 'Mech's damage has reached critical levels. Once activated this system triggers the cockpit canopy to be blown away by explosive bolts and the pilot is rocketed away from the disabled 'Mech. A pilot can choose to **Override Automatic Pilot Ejection** — a practice said to be used by many pilots who prefer to die in their BattleMechs with honor, rather than leaving 'Mech technology to the enemy for salvage or being ejected onto a planet with a hostile atmosphere.

ENHANCED IMAGING

This super-quantified system for image definition (SQUID) uses magnetic resonance to detect and define the edges of objects in a world. These enhanced images are then transmitted into a pilot's neurohelmet as wire-frame images, giving pilots a virtual representation of the outside world. Since **Enhanced Imaging** projects immediate damage infor-

mation of all wire-framed 'Mech units, it is useful in strategic targeting and advanced weapons usage. This system has proven an invaluable environmental aid due to its effectiveness in cutting through dense atmospheric conditions and enabling visibility.

Enhanced Imaging signals can be simultaneously projected into a pilot's neurohelmet while **Pilot Eye Control**, **Tracking View** or the **Satellite Uplink** is activated.

COMMANDING STARMATES

In battles calling for starmate coordination, a MechWarrior in the position of Star commander (Point 1) can access the **Command Computer** to command a starmate.

Starmates at Point 2 or Point 3 can be commanded individually or simultaneously via group orders. Pilots can activate the "Command All" function on the **Command Computer** to issue the same command simultaneously to starmates at Points 2 and 3; or they can command their starmates to carry out independent orders (one at a time) by their Point 2 or 3 designations. The **Command Computer** will display the status of the task currently in progress to the right of the Star position. Starmates at Point 2 and/or 3 can be ordered to follow one of several orders:

■ Change Formation

A MechWarrior can change the active Star formation during combat and his wingmen will reposition themselves accordingly. Pilots can cycle through the six Star formations and select the formation best suited for the situation at hand.

■ Attack Target

A Star commander can assign a particular starmate to attack a predetermined target. This object must first be targeted by the commander before the target information can be transmitted to the wingman.

■ Defend Target

A pilot can also assign a starmate to defend a target. The commanding starmate must first acquire a lock on this object before a wingman can receive the command.

■ Join Formation

A wingman can be called to join formation he's not currently a part of once the battle has commenced.

USE STARMATES
TO DISTRACT
ENEMIES
FROM THEIR
TARGETS.

COMMAND
COMPUTER
CTRL + F1

COMMANDING
STARMATE 2
CTRL + F2

COMMANDING
STARMATE 3
CTRL + F3

■ Disengage and Reform

Once a command has been made or wingman has been otherwise committed, a Star commander can also choose to withdraw the order and call the starmate back to rejoin the formation, regardless of the wingman's current combat status.

■ Engage at Will

This command will order starmates to actively search their radar systems to engage targets as they become readily available.

■ Shutdown

A Star commander can order a starmate to shut down at any point. This practice is effective in camouflaging 'Mechs on an enemy's radar detection system.

ENVIRONMENTAL CONDITIONS

The capabilities of a BattleMech are significantly affected by the environmental conditions of each particular mission. Much consideration should be given to the terrain and atmospheric conditions of the planet where an engagement is to take place.

■ Temperature

Although a 'Mech's propensity to overheat is primarily determined by its size, weapons systems and over-activity, ambient temperatures can also affect a BattleMech's heat dissipation rate. If a planet's temperature is extremely hot or cold, a BattleMech's heat buildup will either increase or decrease accordingly.

■ Atmosphere/Gravity

The varying gravitational and atmospheric conditions of planets can either supplement or limit certain 'Mech capabilities. For example, a planet with lower gravity will enable a 'Mech to jump higher than in a planet with a dense atmosphere as limited by its jump jet energy. Pilots must also be aware of hostile environments which do not allow auto-ejection.

WATCH HEAT
IN HOT WORLDS
TUMCROSS

→
SLOW HEAT
DISSIPATION
IN DESERT !!

↘
HIGH GRAVITY
= SLOW MOVEMENT
= ↓ JUMP
CAPACITY

■ Terrain

The varying types of terrain can have a significant effect on a BattleMech's efficiency. The ease in navigational ability can be determined by the frictional coefficient on any sloped terrain. Man-walker 'Mechs are more effective deployments on rugged terrain than reverse-joint chicken-walkers since the latter type is lower to the ground and features less leg flexibility for climbing mountains or going over steep inclines.

■ Time of Day

The time of day during which a mission occurs can have a significant effect on a Mech-Warrior's piloting capability. Since environmental changes can be detected in worlds with changing times of day, pilots must consider such effects prior to deployment of a specific 'Mech configuration and the use of their in-cockpit systems such as **Low-Light Amplification** or **Enhanced Imaging**.

LST =
GALACTIC
STAN. TIME



APPENDIX A — DEFAULT CONTROL CONFIGURATION SYSTEMS

MOUSE

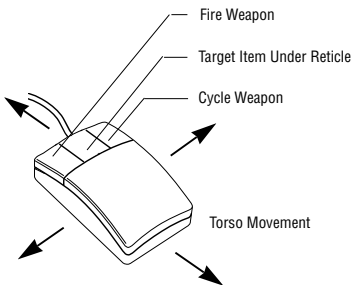

CH JOYSTICK

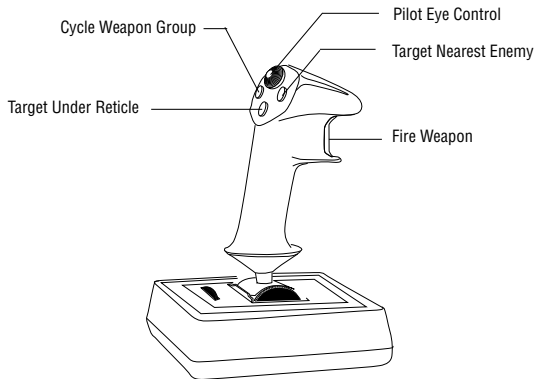

MICROSOFT SIDEWINDER

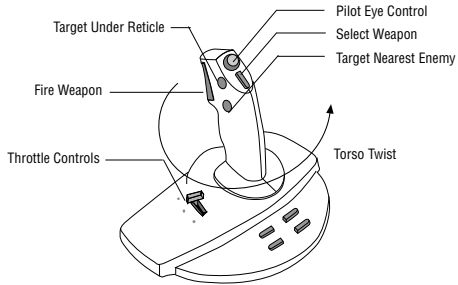

NOTE: Pilots opting to control their BattleMechs with the Gravis Phoenix can access a pre-generated map in the form of custom controller configuration files in a CFGS subdirectory, or create their own.

PHOENIX SYSTEM

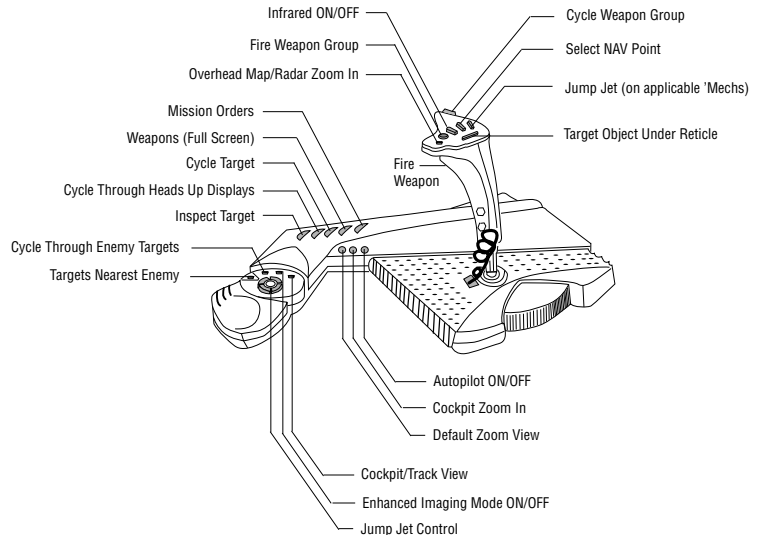

THRUSTMASTER JOYSTICK

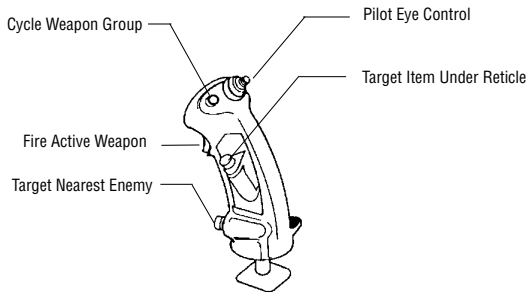

NOTE: Pilots opting to control their BattleMechs with the Thrustmaster WCS can access a pre-generated map in the form of custom controller configuration files in a CFGS subdirectory, or create their own.

THRUSTMASTER MK 1

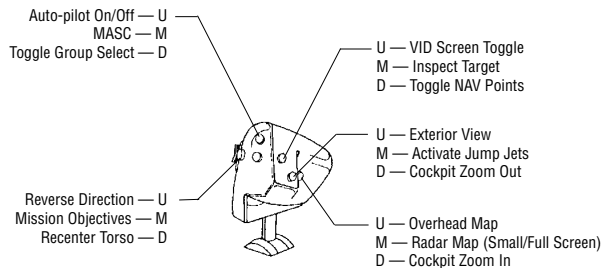

U = Rocker in up position
M = Rocker in middle position
D = Rocker in down position

RUDDER PEDALS

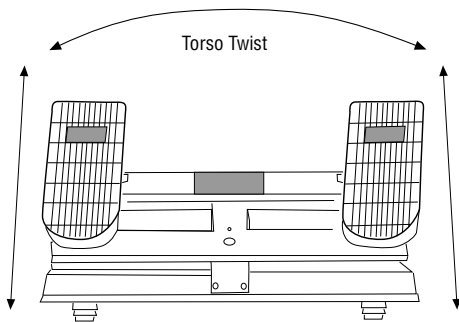

VIRTUAL I/O HELMET

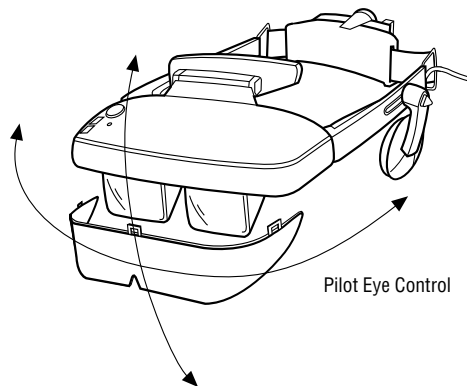

APPENDIX B — PROCEDURES FOR CUSTOMIZING A BATTLEMECH

There are two basic considerations in balancing a BattleMech: (1) maximum weight and (2) critical space. Maximum weight is determined by the total allowable tonnage for the base chassis selected. Critical space refers to the critical slots in each section of a BattleMech designed to house weapons and 'Mech system components. The capacity of these areas is determined by the BattleMech's tonnage and a pre-allocated assignment of critical space to the base chassis, the main framework of each BattleMech. The available critical slots in each section of the base chassis determine the space in which to allocate the primary components of a 'Mech.

Select the **'MECH LAB** Holo projector from the **READY ROOM** to begin the BattleMech customization process. Before adding a component to your 'Mech, check your current mass for allowable weight, making sure that the critical slots required to carry it are available in your 'Mech's internal structure. Once you complete the procedures for customizing a 'Mech, you can select **SAVE** and enter your custom name to add it to the **'MECH LAB** or **ABORT** to return to the **READY ROOM** at any time during the following 'Mech design process.

STEP 1 — DETERMINE BASE CHASSIS

There are 15 base chassis in the 'Mech Design Lab ranging from a base tonnage of 20 to 100, plus alternate variants for each. Select the **'MECH LAB** Holo projector and use the **PREV/NEXT VARIANT** and **PREV/NEXT CHASSIS** arrows to cycle through all the customizable 'Mechs and variants available. Once the base chassis you want to customize is displayed on the holo projector, select **CUSTOMIZE** to access that configuration's specifications. The base chassis you select determines your 'Mech's maximum tonnage capacity — this is your starting point. The total weight of the BattleMech's engine, weapons, armor and additional components cannot exceed this base tonnage to construct a legal 'Mech.

STEP 2 — SELECT ENGINE

Choose an engine for your BattleMech. Select "**Engine**" from the configuration summary to display the Engine screen. Select **FASTER** or **SLOWER** to scroll through the BattleMech engines available. Once you have determined the engine you will use in your BattleMech, click on the type of engine on the Engine screen to toggle between **Std** (Standard) or **XL** (Extra Light) engine technology. An XL-type engine weighs half as much as a standard engine of the same rating, but occupies additional critical slots in each side of a 'Mech's Torso.

STEP 3 — MODIFY HEAT SINKS

Every BattleMech engine is equipped with heat sinks as standard equipment, but some 'Mechs will need additional heat sinks to effectively dissipate heat, depending on their weapons configuration. Select "**Heat Sinks**" on the configuration summary to display the Heat Sinks screen. A BattleMech may not carry a mix of normal and double heat sinks. Select **ADD** and **DELETE** to determine the number of heat sinks you'd like your 'Mech to carry. Then, click on the type of heat sink technology to toggle between **Single** or **Double** heat sinks. The total weight of the default heat sinks is included in the engine tonnage; extra heat sinks can be added at a weight cost per heat sink. The critical slots required for the total number of heat sinks added is determined by the 'Mech's engine rating.

STEP 4 — DETERMINE JUMP CAPABILITY

BattleMechs may be equipped with jump jets in their Legs and/or Torsos to allow jump capability. Each jump jet gives a 'Mech additional jump capability. Select "**Jump Jets**" from the configuration summary to display the Jump Jets screen. Select **ADD** and **DELETE** arrows to set your 'Mech's desired jump jet mass/capability. Once you set the desired number of jump jets, the Jump Jets screen will indicate the total jump jet tonnage added.

STEP 5 — DETERMINE INTERNAL STRUCTURE

The internal structure of a 'Mech can be constructed with standard or Endo Steel technology. Select "**Internal**" to display the Internal Structure screen. Although using Endo Steel frees up tonnage that can be used to add weapons and armor, it requires more critical slots to be carried by a 'Mech. Click on the type of internal structure technology to toggle between **Std** (Standard) or **Endo-S** (Endo-Steel).

STEP 6 — MODIFY ARMOR

You can add armor to your 'Mech in half-ton increments and as much as your 'Mech's internal structure will allow. The armor factor is based on a 'Mech's armor type and tonnage. Select "**Armor**" to display the Armor screen. You can add twice as much armor as internal structure to each area of a 'Mech's torso, arms and legs, and three times as much to a 'Mech's head. Select **ADD** or **DELETE** to modify your 'Mech with the desired armor. Click on the type of armor to select either **Std** (Standard) or **Ferro-F** (Ferro-Fibrous) armor technology. For each ton of standard armor added, you are supplied with plates of armor which you can distribute to your 'Mech's structure. Ferro-Fibrous armor increases the armor factor per ton, but occupies more critical slots in a 'Mech's internal structure. Once you determine the total tonnage of armor to add, you can distribute the selected number of plates of armor to the different sections in your BattleMech's internal structure.

The exact armor factor used to protect each area is left to your discretion. Use the 'Mech diagram on the Armor Allocation screen to select the section of the 'Mech to which you would like to add armor, then use the first set of arrows on the left to increase or decrease the amount of armor allocated to those areas. For areas to which armor can be allocated to front and back sections, use the second set of arrows to increase or decrease armor accordingly. The Armor Allocation screen will indicate the armor assigned to each section of the BattleMech.

STEP 7 — ADD WEAPONS AND AMMUNITION

You can add up to ten weapons and as much ammo as your BattleMech's total tonnage and critical slots will support. Select "**Weapons**" to display the Weapons screen. Check the Weapons and Ammo screen to determine which weapons are included on the current configuration. Then review the Weapons Table on the right to determine which weapons are available for incorporation into your custom 'Mech.

To add a weapon to your configuration, select the weapon you would like to add from the Weapons Table to display its specifications in the Weapon Info screen. Then, select **ADD WEAPON** to add it to the 'Mech's weapons configuration. The added weapon will then appear on the Weapons and Ammo screen to indicate its presence on the 'Mech being customized. To delete a weapon, just select it from the Weapons Table, then select **DELETE WEAPON** to remove it from the configuration.

If the weapon you have added is an ammunition-based weapon (i.e., non-energy weapon), you can add or delete ammo in keeping with the base chassis's allowable tonnage and critical space — select **ADD AMMO** or **DELETE AMMO** from the Weapons and Ammo screen accordingly to change the amount of ammo for the currently selected weapon.

STEP 8 — ADD EQUIPMENT

Select "**Equipment**" on the configuration summary to display the Equipment screen. Each 'Mech is equipped with several mandatory equipment systems which are accounted for in the design of a BattleMech. Both mandatory and assignable equipment will appear on the Equipment screen to indicate which systems are included in your configuration. In addition to various actuators and CASE, the other type of equipment your 'Mech configuration can be equipped with is **MASC** to enable a 'Mech with the capability of short bursts of speed at the cost of heat build-up and increased stresses. Select **MASC** from the Equipment screen to either equip your configuration with, or remove **MASC**. The Equipment screen will indicate its presence or absence on the current configuration.

STEP 9 — ASSIGN CRITICALS

Once you have customized your 'Mech with all the components desired, you must assign them to critical slots in your 'Mech's internal structure. Select "**ASSIGN CRITICALS**" to display the Criticals screen.

The number of blank slots in a given internal structure section acts as a limit to the number of weapons and other equipment that can be carried in this section. For example, if the Center Torso only has two empty slots remaining, and a PPC takes up three slots, a PPC cannot be placed in the BattleMech's Center Torso. To free up slots in a 'Mech's internal structure, you can move any non-required equipment to another section in your 'Mech.

Check the Unassigned Criticals screen to determine the different components that must still be assigned to a section of your BattleMech configuration. Select the current internal structure section displayed to the left to determine the areas with available critical space, indicated by a blank section. (Click on the section to cycle through the components contained in each.)

Only a portion of the BattleMech's heat sinks have to be allocated to critical slots. Default heat sinks are assumed to be an integral part of the engine and are only destroyed if the engine is totally destroyed.

All weapons and equipment must be assigned to critical slots in a single location. Each ton of ammunition occupies one critical slot. The slot required for this ton of ammunition does not have to be assigned to the same location as the weapon using the ammo.

You can re-assign a component that has already been assigned to critical slots in a 'Mech. Just click on the component on the particular internal structure section from which you want to remove it, and it will appear in the Unassigned Criticals screen. You can then reassign it to another 'Mech area. Once you have assigned all components to the required critical slots in your 'Mech's internal structure, the Unassigned Criticals screen should be empty.

Select **SAVE** to add your 'Mech configuration to the **'MECH LAB**. A prompt will appear at the top of the configuration summary to allow you to type in a variant letter, or backspace to rename it. You can then select **ACCEPT** to take your customized 'Mech out to the battlefield.

APPENDIX C — WEAPONS SYSTEMS

WEAPONS CHART

WEAPON TYPE	HEAT	DAMAGE	RANGE (IN METERS)	TONNAGE	CRITICAL	AMMO (PER TON)
ER Laser (Lg)	12	10	1019	4	1	—
ER Laser (Med)	5	7	510	1	1	—
ER Laser (Sm)	2	5	255	0.5	1	—
ER PPC	15	15	746	6	2	—
Pulse Laser (Lg)	10	10	815	6	2	—
Pulse Laser (Med)	4	7	408	2	1	—
Pulse Laser (Sm)	2	3	204	1	1	—
Gauss Rifle	1	15	1820	12	6	8
LB 2-X AC	1	2	800	5	8	45
LB 5-X AC	1	5	700	7	4	20
LB 10-X AC	2	10	600	10	5	10
LB 20-X AC	6	20	450	12	9	5
Machine Gun	0	2	175	0.25	1	200
Ultra AC/2	1	2	700	5	2	45
Ultra AC/5	1	5	600	7	3	20
Ultra AC/10	3	10	500	10	4	10
Ultra AC/20	7	20	400	12	8	5
SRM-2	2	2/missile	497	0.5	1	50
SRM-4	3	2/missile	497	1	1	25
SRM-6	4	2/missile	497	1.5	1	15
Streak SRM-2	2	*	497	1	1	50
Streak SRM-4	3	*	497	2	1	25
Streak SRM-6	4	*	497	3	2	15
LRM-5	2	1/missile	1000	1	1	24
LRM-10	4	1/missile	1000	2.5	1	12
LRM-15	5	1/missile	1000	3.5	1	8
LRM-20	6	1/missile	1000	5	4	6

WEAPONS DESCRIPTIONS

EXTENDED-RANGE LASERS

The extended-range laser is an upgraded version of the basic Clan laser with improvements that are obvious in its superior beam focusing and targeting equipment. The small extended-range laser is the lightest of all. It causes less damage than the large version and generates less heat. The medium version is heavier than the small version, but with more of the same advantages and drawbacks of the larger model. The large version of the ER laser has a significant increase in range and a damage potential that is slightly higher than the basic model, at a cost of substantially more heat than the other versions.

EXTENDED-RANGE PPC

The Particle Projection Cannon fires high energy ion bolts which cause damage through both the impact and high temperature. Extended-range PPC is a significantly improved version of the particle projection cannon. This PPC is smaller, lighter and more powerful than the basic version with its longer range and harder punch. Heat buildup is also much higher and could be a critical disadvantage of employing this weapon.

PULSE LASERS

The pulse laser uses a rapid-cycling, high-energy pulse to generate multiple laser beams, creating an effect comparable to machine-gun fire. This characteristic improves each laser attack's hit probability with more damage per hit at the cost of increased heat and a somewhat shorter effective range. They too are available in Small, Medium and Large versions.

GAUSS RIFLE

The Gauss rifle uses a series of magnets to propel a projectile through its barrel and towards a target. While requiring a great deal of power to operate, it generates very little heat and can achieve a muzzle velocity twice that of any conventional weapon. Gauss rifle ammunition consists of nickel-ferrous metal slugs. If Gauss ammunition takes a critical hit, there is no explosion, but the hit destroys the ammo-feed mechanism rendering the rest of the ammunition in that location useless. A critical hit on the Gauss rifle itself

destroys the capacitors that power this weapon. Such destruction causes a catastrophic discharge of the capacitor's stored energy with results similar to an ammunition explosion. If a Gauss rifle takes a critical hit, it causes an ammunition explosion in the location containing the rifle.

LB-X AUTOCANNON

The LB-X autocannon makes use of light, heat-dissipating alloys to reduce weight and heat buildup. The reduced space and weight requirement of the LB-X autocannon allows this weapon to mount more sophisticated fire-control systems.

In addition to these advantages, the LB-X autocannon can use special cluster munitions that act much like an anti-BattleMech shotgun in combat. When fired, the ammunition fragments into several smaller submunitions. This improves the chances of scoring a hit and striking a critical location, but reduces overall damage by spreading hits all over the target area rather than concentrating on one location. The 5X autocannon causes five times as much damage as the common model, and the 20X causes 20 times more damage than the common model.

MACHINE GUN

The Clan machine gun is a rapid-fire weapon. It is one of the lightest, yet powerful weapons a BattleMech can carry. The sheer volume of machine gun bullets which can be shot at close range increases the probability of scoring a hit, but does not cause severe damage to its target.

ULTRA AUTOCANNON

The ultra autocannon features a short, smooth-bore barrel, a modified breech mechanism, a rapid-feed reloader and specially designed ammunition. The AC/5 version, a multiple configuration possessed by the Clans, causes five times more damage than the common model. The ultra AC/10 causes ten times the damage and more heat build-up, while the largest version causes 20 times the damage.

SHORT-RANGE MISSILES

Short-range missiles are specially designed to fire at close range. Although the SRM-2 missile fires only two missiles at once, it can cause more the damage of a missile in the long range missile group. The SRM-4 fires four missiles at once and the SRM-6 version delivers six missiles in one powerful shot.

STREAK SHORT-RANGE MISSILES

These short-range missile launchers are linked to a computerized fire-control system which handles target acquisition. Once the computer obtains a target lock, the streak missile will automatically home in on its target. The sure-hit SRM-2 fires two missiles at once while the SRM-4 blasts four missiles worth of firepower. The SRM-6 tops the streak missile family with a six-pack blast of guided bliss.

LONG-RANGE MISSILES

The long-range missile is a specialized weapon designed to make contact with its target at long range through the use of its guidance system. The LRM-5 sends off a five-pack of missiles at once. The LRM-10 fires off ten missiles with one blast. The LRM-15 fires off a 15-pack of missiles and the LRM-20 leads this family of missiles with a 20-pack of pure missile power. Its indirect hits have been known to be as effective as its direct hits due to area-effect explosions known as "splash damage."

APPENDIX D — DIAGRAMS OF THE BATTLEMECHS (PRIMARY CONFIGURATIONS)

FIREMOTH



Mass:	20 tons
Chassis:	Endo Steel
Power Plant:	200 XL
Cruising Speed:	108 kph
Maximum Speed:	162 kph
Jump Jets:	None
Jump Capacity:	None
Armor:	Ferro-Fibrous

	Internal Structure	Armor Value		
Head	3	5		
Center Torso	6	5		
Center Torso (rear)		2		
R/L Torso	5	4		
R/L Torso (rear)		2		
R/L Arm	3	3		
R/L Leg	4	4		

Primary Weapons Configuration			
Weapons & Ammo	Location	Critical	Ton
ER Medium Laser	LA	1	1
ER Medium Laser	LA	1	1
SRM-6	RA	1	1.5
Ammo (SRM) 15	RA	1	1
CASE	RA	0	0
SRM-4	RT	1	1
Ammo (SRM) 25	RT	1	1
CASE	RT	0	0

Weight and Space Allocation

Location	Fixed	Space Remaining
Head	Ferro-Fibrous	0
Center Torso	MASC	
	Endo Steel	0
Right Torso	2 Engine	
	2 Ferro-Fibrous	
	Endo Steel	
	Double Heat Sink	5

Weight and Space Allocation (cont'd)

Location	Fixed	Space Remaining
Left Torso	2 Engine	
	2 Ferro-Fibrous	
	Endo Steel	
	Double Heat Sink	5
Right Arm	Ferro-Fibrous	
	Endo Steel	7
Left Arm	Ferro-Fibrous	
	Endo Steel	7
Right Leg	Endo Steel	1
Left Leg	Endo Steel	1

Capabilities

The Firemoth's primary configuration can give a good account of itself against any light 'Mech. Its exceptional speed allows it to confront its enemy at close range and use its short-range missiles and medium lasers effectively regardless of its opponent's actions. When facing a larger enemy, the Firemoth simply retreats to friendly lines, leaving its foe far behind.

Another popular tactic mastered by the Firemoth includes racing to the enemy's rear and cutting down opposing 'Mechs before they can respond.

KIT FOX



Mass:	30 tons
Chassis:	Endo Steel
Power Plant:	180 XL
Cruising Speed:	64.8 kph
Maximum Speed:	97.2 kph
Jump Jets:	None
Jump Capacity:	None
Armor:	Ferro-Fibrous

	Internal Structure	Armor Value
Head	3	9
Center Torso	10	9
Center Torso (rear)		5
R/L Torso	7	8
R/L Torso (rear)		4
R/L Arm	5	7
R/L Leg	7	8

Primary Weapons Configuration

Weapons & Ammo	Location	Critical	Ton
ER Large Laser	LA	1	4
Small Pulse Laser	LA	1	1
Streak SRM-4	RA	1	2
Ammo (Streak) 25	RA	1	1
CASE	RA	0	0
LB-5X	RA	4	7
Ammo (AC) 20	RA	1	1

Weight and Space Allocation

Location	Fixed	Space Remaining
Head	Ferro-Fibrous	0
Center Torso	Double Heat Sink	0
Right Torso	2 Engine	
	2 Ferro-Fibrous	
	3 Endo Steel	5
Left Torso	2 Engine	
	2 Ferro-Fibrous	
	2 Endo Steel	6
Right Arm	Ferro-Fibrous	
	Endo Steel	7
Left Arm	Ferro-Fibrous	
	Endo Steel	7
Right Leg	Double Heat Sink	0
Left Leg	Double Heat Sink	0

Capabilities

The Kit Fox's configuration is equipped with four of the most advanced weapons available. Its main firepower comes from the LB-5X Autocannon in its Right Arm and the extended-range large laser in its Left. A small pulse laser and streak SRM-4 add to the Kit Fox's punch at close range. This marvel of design keeps heat buildup in check, economizes on missile loads to avoid running out of ammunition and provides sting at varying ranges.

JENNER II-C



Mass: 35 tons
 Chassis: Endo Steel
 Power Plant: 315 XL
 Cruising Speed: 97.2 kph
 Maximum Speed: 151.2 kph
 Jump Jets: 7
 Jump Capacity: 210 meters
 Armor: Ferro-Fibrous

	Internal Structure	Armor Value
Head	3	7
Center Torso	11	13
Center Torso (rear)		7
R/L Torso	8	8
R/L Torso (rear)		4
R/L Arm	6	4
R/L Leg	8	9

Primary Weapons Configuration

Weapons & Ammo	Location	Critical	Ton
SRM-4 Streak	CT	1	2
Ammo (SRM Streak) 25	RT	1	1
SRM-6	RA	1	1.5
Ammo (SRM) 15	RT	1	1
SRM-6	LA	1	1.5
Ammo (SRM) 15	LT	1	1
CASE	RT	0	0
Jump Jets	LL	3	1.5
Jump Jets	RL	3	1.5
Jump Jets	RT	1	0.5
CASE	LT	0	0

Weight and Space Allocation

Location	Fixed	Space Remaining
Head		1
Center Torso	Jump Jets	1
Right Torso	2 Engine	
	2 Double Heat Sinks	6
Left Torso	2 Engine	
	2 Double Heat Sinks	6
Right Arm		8
Left Arm		8
Right Leg	2 Jump Jets	0
Left Leg	2 Jump Jets	0

Capabilities

The Jenner II-C's speed has been exploited to make one of the fastest and most maneuverable 'Mechs in existence. Designers have reinforced its Center Torso and Leg armor for increased survivability, and its powerful jump jets give it an incredible 240-meter jump capability.

NOVA



Mass:	50 tons
Chassis:	Standard
Power Plant:	250 XL
Cruising Speed:	54 kph
Maximum Speed:	86.4 kph
Jump Jets:	5
Jump Capacity:	150 meters
Armor:	Standard

	Internal Structure	Armor Value
Head	3	9
Center Torso	16	23
Center Torso (rear)		8
R/L Torso	12	17
R/L Torso (rear)		7
R/L Arm	8	16
R/L Leg	12	20

Primary Weapons Configuration

Weapons & Ammo	Location	Critical	Ton
ER Medium Laser	LA	1	1
ER Medium Laser	LA	1	1
ER Medium Laser	LA	1	1
ER Medium Laser	LA	1	1
ER Medium Laser	LA	1	1
ER Medium Laser	LA	1	1
Double Heat Sink (1)	LA	2	1
Double Heat Sink (1)	LT	2	1
ER Medium Laser	RA	1	1
ER Medium Laser	RA	1	1
ER Medium Laser	RA	1	1
ER Medium Laser	RA	1	1
ER Medium Laser	RA	1	1
ER Medium Laser	RA	1	1
ER Medium Laser	RA	1	1
Double Heat Sink (1)	RA	2	1
Double Heat Sink (1)	RT	2	1

Weight and Space Allocation

Location	Fixed	Space Remaining
Head		1
Center Torso	Jump Jets	1
Right Torso	2 Engine	
	2 Double Heat Sinks	6
Left Torso	2 Engine	
	2 Double Heat Sinks	6
Right Arm		8
Left Arm		8
Right Leg	2 Jump Jets	0
Left Leg	2 Jump Jets	0

Capabilities

The Nova has an unusual appearance and fearsome capabilities. Each hexagonal weapons pod on each arm boasts six medium lasers that provide exceptional firepower, but generate too much heat for sustained firing. The Nova mounts four additional double heat sinks to allow the pilot more freedom to use his weapons; nevertheless, a pilot who fires all 12 lasers in one salvo risks immediate shutdown.

STORM CROW



Mass:	55 tons
Chassis:	Endo Steel
Power Plant:	330 XL
Cruising Speed:	64.8 kph
Maximum Speed:	97.2 kph
Jump Jets:	None
Jump Capacity:	None
Armor:	Ferro-Fibrous

	Internal Structure	Armor Value
Head	3	9
Center Torso	18	25
Center Torso (rear)		11
R/L Torso	13	17
R/L Torso (rear)		9
R/L Arm	9	18
R/L Leg	13	26

Primary Weapons Configuration

Weapons & Ammo	Location	Critical	Ton
ER Medium Laser	CT	1	1
ER Large Laser	LA	1	4
ER Medium Laser	LA	1	1
Double Heat Sink (3)	LT	6	3
ER Large Laser	RA	1	4
ER Medium Laser	RA	1	1
Double Heat Sink (3)	RA	6	3
Double Heat Sink (3)	RT	6	3

Weight and Space Allocation

Location	Fixed	Space Remaining
Head	Ferro Fibrous	0
Center Torso	Endo Steel	1
Right Torso	2 Engine	
	3 Ferro-Fibrous	
	Endo Steel	6
Left Torso	2 Engine	
	3 Ferro-Fibrous	
	Endo Steel	6
Right Arm		9
Left Arm		9
Right Leg	2 Endo Steel	0
Left Leg	2 Endo Steel	0

Capabilities

The Inner Sphere was totally unprepared for a 'Mech equipped with double-barreled lasers on each arm and the heat sinks that allow the pilot to use them. The configuration of the Storm Crow could devastate a foe in moments. The speed and firepower of this version of the Storm Crow commands the respect of any military force.

MAD DOG



Mass:	60 tons
Chassis:	Standard
Power Plant:	300 XL
Cruising Speed:	54 kph
Maximum Speed:	86.4 kph
Jump Jets:	None
Jump Capacity:	None
Armor:	Ferro-Fibrous

	Internal Structure	Armor Value
Head	3	9
Center Torso	20	23
Center Torso (rear)		7
R/L Torso	14	16
R/L Torso (rear)		7
R/L Arm	10	16
R/L Leg	14	23

Primary Weapons Configuration

Weapons & Ammo	Location	Critical	Ton
Large Pulse Laser	LA	2	6
Medium Pulse Laser	LA	1	2
LRM 20	LT	4	5
Ammo (LRM) 6	LT	1	1
CASE	LT	0	0
Large Pulse Laser	RA	2	6
Medium Pulse Laser	RA	1	2
LRM-20	RT	4	5
Ammo (LRM) 6	RT	1	1
CASE	RT	0	0

Weight and Space Allocation

Location	Fixed	Space Remaining
Head	Ferro Fibrous	0
Center Torso		2
Right Torso	2 Engine	
	2 Ferro-Fibrous	8
Left Torso	2 Engine	
	2 Ferro-Fibrous	8
Right Arm	Ferro-Fibrous	8
Left Arm	Ferro-Fibrous	8
Right Leg		2
Left Leg		2

Capabilities

The Mad Dog serves mostly as a fire-support 'Mech. The twin racks of 20 long-range missiles can certainly hasten along the enemy's death. Should the Mad Dog injure an enemy at long range, it can take fate into its own hands, or arms in this case, and use its laser weapons to finish off its foe.

HELLBRINGER



Mass: 65 tons
 Chassis: Standard
 Power Plant: 325 XL
 Cruising Speed: 54 kph
 Maximum Speed: 86.4 kph
 Jump Jets: None
 Jump Capacity: None
 Armor: Standard

	Internal Structure	Armor Value
Head	3	9
Center Torso	21	17
Center Torso (rear)		8
R/L Torso	15	14
R/L Torso (rear)		7
R/L Arm	10	11
R/L Leg	15	15

Primary Weapons Configuration

Weapons & Ammo	Location	Critical	Ton
CASE	CT	0	0
ER PPC	LA	2	6
ER Medium Laser	LT	1	1
ER Medium Laser	LT	1	1
ER Medium Laser	LT	1	1
ER PPC	RA	2	6
Streak SRM-6	RT	2	3
Ammo (Streak) 15	RT	1	1
Machine Gun	RT	1	0.25
Ammo (MG) 200	RT	1	1
CASE	RT	0	0

Weight and Space Allocation

Location	Fixed	Space Remaining
Head		1
Center Torso		2
Right Torso	2 Engine	10
Left Torso	2 Engine	10
Right Arm		9
Left Arm		9
Right Leg		2
Left Leg		2

Capabilities

The Hellbringer is an electronic marvel. Its blend of weapons systems is a sound combination of ammo efficiency and anti-Mech capabilities, and long- and short-range functions. The only problem with this design is that it cannot handle the massive amounts of heat generated by its mixture of systems. Warriors must be cautious in their choice of targets so that cockpit heat levels do not rise too high.

RIFLEMAN II-C



Mass:	65 tons
Chassis:	Endo Steel
Power Plant:	195 Standard
Cruising Speed:	32.4kph
Maximum Speed:	54.0 kph
Jump Jets:	3
Jump Capacity:	90 meters
Armor:	Ferro-Fibrous

	Internal Structure	Armor Value
Head	3	9
Center Torso	21	30
Center Torso (rear)		12
R/L Torso	15	20
R/L Torso (rear)		10
R/L Arm	10	20
R/L Leg	15	30

Primary Weapons Configuration

Weapons and Ammo	Location	Critical	Ton
Large Pulse Laser	LA	2	6
Large Pulse Laser	LA	2	6
Large Pulse Laser	RA	2	6
Large Pulse Laser	RA	2	6
Jump Jet	LT	1	1
Jump Jet	CT	1	1
Jump Jet	RT	1	1

Capabilities

Visually, the Rifleman looks nothing like the traditional outline that would be recognizable on the battlefield. Like its smaller brother, it mounts a large rotating radar array over its head, but the II-C variant's radar system is mounted much higher with twin box-like appendages fitted on either side of the central support pylon. Close analysis of this 'Mech in action on battlefield vids revealed that this unusual configuration includes a phased radar array that acts in tandem with the main array.

The Rifleman II-C serves as an anti-aircraft BattleMech, with a design that clearly implies a more conservative approach than others. By using a larger 260-rated engine, it retains the expected performance envelope of a standard Rifleman. This model's ferro-fibrous armor was eliminated, forcing the 'Mechs to carry two more tons of armor for effective cover. This variant of the Rifleman carries four ultra AC/2s, two in each arm, equipped with 135 rounds of ammunition for each pair stored in the adjacent Torso sections. While it lacks the firepower of the standard version, this variant is a formidable weapons platform with ample ammunition to fulfill the anti-aircraft mission.

SUMMONER



ass:	70 tons
Chassis:	Standard
Power Plant:	350 XL
Cruising Speed:	54 kph
Maximum Speed:	86.4 kph
Jump Jets:	5
Jump Capacity:	150 meters
Armor:	Ferro-Fibrous

	Internal Structure	Armor Value
Head	3	9
Center Torso	22	27
Center Torso (rear)		8
R/L Torso	15	22
R/L Torso (rear)		7
R/L Arm	11	17
R/L Leg	15	23

Primary Weapons Configuration

Weapons & Ammo	Location	Critical	Ton
LB-10X	LA	5	10
Ammo (AC) 10	LA	1	1
CASE	LA	0	0
LRM-15	LT	2	3.5
Ammo (LRM) 16	LT	2	2
CASE	LT	0	0
ER PPC	RA	2	6

Weight and Space Allocation

Location	Fixed	Space Remaining
Head	Ferro-Fibrous	0
Center Torso	Jump Jets	1
Right Torso	2 Engine	
	2 Ferro-Fibrous	8
Left Torso	2 Engine	
	2 Ferro-Fibrous	8
Right Arm	Ferro-Fibrous	8
Left Arm	Ferro-Fibrous	8
Right Leg	2 Jump Jets	0
Left Leg	2 Jump Jets	0

Capabilities

The huge Summoner, standing at least a meter taller than most other 'Mechs, appears most often in a configuration that is remarkable considering its lack of laser weaponry. Its mix of weapons complements this 'Mech's maneuverability to make it a deadly foe. This model carries a long-range missile launcher on its Left Shoulder, a PPC in one hand, and a heavy autocannon in the other.

TIMBER WOLF



Mass:	75 tons
Chassis:	Endo Steel
Power Plant:	375 XL
Cruising Speed:	54 kph
Maximum Speed:	86.4 kph
Jump Jets:	None
Jump Capacity:	None
Armor:	Ferro-Fibrous

	Internal Structure	Armor Value
Head	3	9
Center Torso	23	36
Center Torso (rear)		9
R/L Torso	16	24
R/L Torso (rear)		8
R/L Arm	12	24
R/L Leg	16	32

Primary Weapons Configuration

Weapons & Ammo	Location	Critical	Ton
Machine Gun	CT	1	0.25
ER Large Laser	LA	1	4
ER Medium Laser	LA	1	1
Double Heat Sink (1)	LA	2	1
Medium Pulse Laser	LT	1	2
LRM-20	LT	4	5
Ammo (LRM) 6	LT	1	1
CASE	LT	0	0
ER Small Laser	LT	1	0.5
ER Large Laser	RA	1	4
ER Medium Laser	RA	1	1
Double Heat Sink (1)	RA	2	1
Machine Gun	RT	1	0.25
Ammo (MG) 200	RT	1	1
Ammo (MG) 400	RA	1	1
CASE	RA	0	0
LRM 20	RT	4	5
Ammo (LRM) 6	RT	1	1
CASE	RT	0	0

Weight and Space Allocation

Location	Fixed	Space Remaining
Head	Ferro-Fibrous	0
Center Torso	Endo Steel	1
Right Torso	2 Engine	
	2 Ferro-Fibrous	
	Endo Steel	7
Left Torso	2 Engine	
	2 Ferro-Fibrous	
	Endo Steel	7
Right Arm	Ferro-Fibrous	8
Left Arm	Ferro-Fibrous	8
Right Leg	2 Endo Steel	0
Left Leg	2 Endo Steel	0

Capabilities

The Timber Wolf displays impressive firepower, starting with double LRM-20 racks on the Shoulders, and weapons pods on each Arm containing an extended-range large laser and an extended-range medium laser. The Timber Wolf also incorporates pulse technology with a medium pulse laser on the Right side of the Torso, and a dual machine gun system to round out its weaponry.

GARGOYLE



Mass:	80 tons
Chassis:	Standard
Power Plant:	400 XL
Cruising Speed:	54 kph
Maximum Speed:	86.4 kph
Jump Jets:	None
Jump Capacity:	None
Armor:	Ferro-Fibrous

	Internal Structure	Armor Value
Head	3	9
Center Torso	25	30
Center Torso (rear)		10
R/L Torso	17	24
R/L Torso (rear)		10
R/L Arm	13	23
R/L Leg	17	24

Primary Weapons Configuration

Weapons & Ammo	Location	Critical	Ton
ER Small Laser	CT	1	0.5
LB-5X	LA	4	7
SRM-6	LA	1	1.5
Ammo (AC) 10	LT	1	1
CASE	LT	0	0
Ammo (SRM) 15	LT	1	1
LB-5X	RA	4	7
SRM-6	RA	1	1.5
Ammo (AC) 10	RT	1	1
CASE	RT	0	0
Ammo (SRM) 15	RT	1	1

Weight and Space Allocation

Location	Fixed	Space Remaining
Head	Ferro-Fibrous	0
Center Torso		2
Right Torso	2 Engine	
	2 Ferro-Fibrous	8
Left Torso	2 Engine	
	2 Ferro-Fibrous	8
Right Arm	Ferro-Fibrous	8
Left Arm	Ferro-Fibrous	8
Right Leg		2
Left Leg		2

Capabilities

With almost all of its firepower in its Arm weapons pods, the Gargoyle is a versatile design. The most common combination of weapons includes an LB-5 X Autocannon and SRM-6 launcher on each Arm and a small laser in the center torso.

A model that carries a double particle projection cannon in the Right Arm and a triangle of lasers in the Left is almost as frequently seen. A large pulse laser sits above the two medium pulse lasers along with a small laser.

WARHAMMER IIC



Mass:	80 tons
Chassis:	Endo Steel
Power Plant:	320 Standard
Cruising Speed:	43.2 kph
Maximum Speed:	64.8 kph
Jump Jets:	None
Jump Capacity:	None
Armor:	Ferro-Fibrous

	Internal Structure	Armor Value
Head	3	9
Center Torso	25	30
Center Torso (rear)		15
R/L Torso	17	24
R/L Torso (rear)		10
R/L Arm	13	24
R/L Leg	17	30

Primary Weapons Configuration

Weapons & Ammo	Location	Critical	Ton
ER PPC	LA	2	6
ER PPC	RA	2	6
Med. Pulse Laser	H	1	2
Med. Pulse Laser	LT	1	2
Med. Pulse Laser	LT	1	2
SRM-6	RT	1	1.5
Ammo (SRM) 15	RT	1	1
CASE	RT	0	0
Med. Pulse Laser	RT	1	2
Med. Pulse Laser	RT	1	2

Capabilities

The Warhammer was originally designed as an assault 'Mech and, even though it was later eclipsed by heavier 'Mechs, it can still live up to its reputation as one of the most powerful weapon platforms at a commander's disposal.

The Warhammer has a winning combination of speed and firepower that has secured its position in every arsenal. Its strong frame allows many common modifications to be made without losing fighting capacity.

Through our technological expertise, we have transformed the Warhammer into a true assault 'Mech; and managed to add ten tons of weight and also retain its speed and firepower. The result of such design expertise is a very powerful and dangerous 'Mech capable of holding its own on any battlefield.

WARHAWK



Mass:	85 tons
Chassis:	Standard
Power Plant:	340 XL
Cruising Speed:	43.2 kph
Maximum Speed:	64.8 kph
Jump Jets:	None
Jump Capacity:	None
Armor:	Ferro-Fibrous

	Internal Structure	Armor Value
Head	3	9
Center Torso	27	42
Center Torso (rear)		10
R/L Torso	18	26
R/L Torso (rear)		10
R/L Arm	14	28
R/L Leg	18	35

Primary Weapons Configuration

Weapons & Ammo	Location	Critical	Ton
ER PPC	LA	2	6
ER PPC	LA	2	6
LRM-10	LA	1	2.5
Ammo (LRM) 12	LA	1	1
CASE	LA	0	0
ER PPC	RA	2	6
ER PPC	RA	2	6

Weight and Space Allocation

Location	Fixed	Space Remaining
Head	Ferro-Fibrous	0
Center Torso		2
Right Torso	2 Engine 2 Ferro-Fibrous Double Heat Sink	6
Left Torso	2 Engine 2 Ferro-Fibrous 4 Double Heat Sinks	0
Right Arm	Ferro-Fibrous	8
Left Arm	Ferro-Fibrous	8
Right Leg	Double Heat Sink	0
Left Leg	Double Heat Sink	0

Capabilities

The Warhawk, with its paired PPCs in the Arms and a potent long-range missile launcher can destroy smaller 'Mechs with a single blast.

MARAUDER IIC



Mass: 85 tons
 Chassis: Endo Steel
 Power Plant: 340 Standard
 Cruising Speed: 43.2 kph
 Maximum Speed: 64.8 kph
 Jump Jets: None
 Jump Capacity: None
 Armor: Ferro-Fibrous

	Internal Structure	Armor Value
Head	3	9
Center Torso	27	30
Center Torso (rear)		12
R/L Torso	18	26
R/L Torso (rear)		8
R/L Arm	14	24
R/L Leg	18	27

Primary Weapons Configuration

Weapons & Ammo	Location	Critical	Ton
ER PPC	LA	2	6
ER PPC	RA	2	6
ER PPC	LT	2	6
Medium Pulse Laser	LA	1	2
Medium Pulse Laser	RA	1	2
ER Small Laser	LT	1	0.5
ER Small Laser	CT	1	0.5
ER Small Laser	CT	1	0.5
ER Small Laser	RT	1	0.5

Capabilities

The Marauder II-C carries the weaponry layout typical of the standard Marauder. The Forearms each contain extended range PPC's paired with medium pulse lasers. This set-up is familiar as the configuration of the Warhammer, which drops hand actuators to ease maintenance and create a more compact design. The top Torso-mounted weapon on this version is another extended-range PPC, thus avoiding a vulnerable ammunition-feed linkage needed for a projectile weapon.

DIRE WOLF



Mass: 100 tons
 Chassis: Standard
 Power Plant: 300 XL
 Cruising Speed: 32.4 kph
 Maximum Speed: 54 kph
 Jump Jets: None
 Jump Capacity: None
 Armor: Standard

	Internal Structure	Armor Value
Head	3	9
Center Torso	31	47
Center Torso (rear)		14
R/L Torso	21	32
R/L Torso (rear)		10
R/L Arm	17	34
R/L Leg	21	41

Primary Weapons Configuration

Weapons & Ammo	Location	Critical	Ton
Double Heat Sink (1)	CT	2	1
ER Large Laser	LA	1	4
ER Large Laser	LA	1	4
Medium Pulse Laser	LA	1	2
Medium Pulse Laser	LA	1	2
CASE	LA	0	0
LRM-10	LT	1	2.5
Ammo (LRM) 12	LT	1	1
Double Heat Sink (3)	LT	6	3
CASE	LT	0	0
ER Large Laser	RA	1	4
ER Large Laser	RA	1	4
Medium Pulse Laser	RA	1	2
Ultra-5 AC	RA	3	7
Ammo (AC) 20	RA	1	1
CASE	RA	0	0
Double Heat Sink (3)	RT	6	3

Weight and Space Allocation

Location	Fixed	Space Remaining
Head		1
Center Torso		2
Right Torso	2 Engine	
	Double Heat Sink	8
Left Torso	2 Engine	
	Double Heat Sink	8
Right Arm		9
Left Arm		9
Right Leg		2
Left Leg	Double Heat Sink	0

Capabilities

The Dire Wolf features an LRM-10 rack on the Left Shoulder. Each Arm consists of a bundle of death, namely an Ultra-5 Autocannon, two large lasers and two medium pulse lasers. Seven double-strength heat sinks are mounted in the Torso of this 'Mech to deal with some of the heat buildup.

APPENDIX E — GLOSSARY

(based on the FASA BattleTech descriptions)

BATCHALL

The batchall is a ritual by which Clan warriors issue combat challenges. Though the type of challenge varies, most begin with the challenger identifying himself, stating the prize of the contest and requesting that the defender identify the forces at his disposal. The defender also has the right to name the location of the trial.

BLOODNAME

Bloodname refers to the surname of each of the 800 warriors who stood with Nicholas Kerensky during the Exodus Civil War. These 800 are the foundation of the Clans' elaborate breeding program. The right to use one of these surnames has been the ambition of every Clan warrior since the system was established.

BLOODRIGHT

The specific bloodname lineage is called a bloodright. Twenty-five bloodrights are attached to each bloodname.

CASTE

Clan society is rigidly divided into five castes: warrior, scientist, merchant, technician and laborer. Each caste has many subcastes that are based on specialties within a professional field.

CLANS

During the fall of the Star League, General Aleksandr Kerensky, commander of the Regular Star League Army, led his forces out of the Inner Sphere in what is known as the First Exodus. After settling beyond the Periphery, more than 1,300 light years away from Terra, Kerensky and his followers settled in a cluster of marginally habitable star systems near a large global cluster that hid them from the Inner Sphere.

CRUSADERS

The Crusaders believe Kerensky's words to mean that the Inner Sphere is theirs by right. Their goal is to retake Terra at whatever the cost, by whatever force or bloodshed necessary.

DEZGRA

A fighting unit that disgraces itself is known as a dezgra unit. The name also refers to the ritual whereby that unit is marked and punished. Any unit that refuses orders, panics in the face of the enemy, or takes dishonorable action is disgraced.

ELEMENTALS

Elementals are the elite, battle-suited infantry of the Clans. These men and women are giants, bred specifically to handle Clan-developed battle armor.

KESHIK

Keshik is the ruling military group of the Clans responsible for delegating all military orders, including the evaluation of a MechWarrior's eligibility for career advancement.

KHAN

Each Clan elects two leaders, or khans. One serves as the Clan's senior military commander and bureaucratic administrator. The second khan's position is less well defined. He or she is second-in-command, carrying out duties assigned by the first khan.

KURULTAI

A kurultai is a Clan war council.

OVKHAN

This is a term of respect for someone of higher rank.

QUIAFF/QUINEG

This Clan expression is placed at the end of rhetorical questions. If an affirmative answer is expected, quiaff is used. If the answer is expected to be negative, quineg is the proper closure.

THE REMEMBRANCE

The Remembrance is an ongoing heroic saga detailing Clan history from the time of the Exodus from the Inner Sphere to the present day.

RISTAR

This term refers to a particularly gifted warrior on his or her way to high position.

SIBKO

A sibko consists of a group of children produced from the

same male and female geneparents in the warrior caste eugenics program.

STRAVAG

This is a Clan epithet, probably a combination of the Clan words *stran*, meaning independent, and *vagon*, meaning birthing.

SURKAI

The surkai is the Right of Forgiveness. The Clans honor uniformity of thought and belief about all else in their society.

TOUMAN

This is the term given to the fighting army of a Clan.

TRIAL OF BLOODRIGHT

This is a series of one-on-one, single-elimination contests that determines who wins the right to use a bloodname.

TRIAL OF POSITION

The Trial of Position determines a candidate's right to receive a higher Clan position or ranking. To qualify, all objectives of the Trial must be achieved.

THE WARDENS

The Wardens are the Clan protectors of the Inner Sphere. They interpret the words of Kerensky to mean that they must aid and protect the Inner Sphere to bring its enlightenment.

ZELLBRIGEN

This is the Clan word describing the body of rules used to regulate and ritualize duels. Zellbrigen means the combatants engage in one-on-one duels, even if both sides have many warriors.

APPENDIX F — NETMECH FOR MS-DOS

Note: You can skip the title screen movie and go immediately to the Transport Selection Screen by pressing **Esc**.

TRANSPORT SELECTION SCREEN

Change to the hard drive and directory where you installed *NetMech*. At the DOS prompt, type **NETMECH**. If you're running Windows 95, you can start *NetMech* by opening the folder in which you installed it, and double-clicking on the **NetMech** icon. After a brief introduction, a screen with the following selections will appear.

ENTER CALLSIGN — Type in your name. Note: This field must be filled, or you will not be able to enter the game.

SELECT CONNECTION TYPE — Choose **IPX** if you wish to play via IPX network; **Null Modem** if you wish to play via direct cable hookup between two computers; or **Modem** if you wish to play via modem. Click on your selection, then click the **SELECT** button or press **Enter**.

Note: If you choose **IPX**, you will be taken directly to the Game Selection Screen.

QUIT — Click this button to exit *NetMech* and retreat to the safety of your operating system.

QUICK HELP — As you move your cursor around, a brief description of each section of the screen will appear here.

TELECOM CONNECTION SCREEN

If you choose **Modem** in the Transport Selection Screen, a screen with the following selections will appear. Note: Only two warriors can play via modem.

WARRIORS — The callsigns of the players appear here.

PHONE NUMBER — Listed here is the phone number of your fellow *NetMech* player.

ADD — If you click this button, the Warrior Entry Screen will appear, allowing you to add new warriors and their phone numbers. Enter the name and number and click on **ACCEPT**.

EDIT — If you click on this button, the Warrior Entry Screen will appear, allowing you to edit any name and number that you wish.

DELETE — Highlight the name and number you wish to delete, then click on this button.

MODEM SETTINGS — If you click on this button, the Modem Setting Screen will appear. Select your settings for Modem Type, Com Port and Baud Rate, then click on **ACCEPT**. You will also be able to read your Modem Init. String, but if you wish to add a new modem type, you must exit the game and do so in DOS with **EDIT MODEM.LST**.

QUICK HELP — As you move your cursor around, a brief description of each section of the screen will appear here.

BACK — Click this button to return to the Transport Selection Screen.

DIAL and **ANSWER** — Because one player must click on **DIAL** and the other one on **ANSWER**, you should decide beforehand who will do which. If you both click the same button, a dialog box will appear indicating that the line is busy. Note: You might wish to disable Call Waiting by attaching the disabling code to the beginning of the phone number. (Normally this disabling code is `*70` or `#70`, however, check with your local telephone service provider for more information.) Once the connection is made, you will be taken to the Game Selection Screen.

QUIT — Click this button to exit *NetMech* and retreat to the safety of your operating system.

SELECT COMMUNICATIONS PORT SCREEN

If you choose **Null Modem**, to play via direct cable link between two players, a screen with the following selections will appear.

BACK — Click this button to return to the Transport Selection Screen.

ACCEPT — Highlight the com port you wish to use and then click here. You will then be taken to the Game Selection Screen.

QUIT — Click this button to exit *NetMech* and retreat to the safety of your operating system.

QUICK HELP — As you move your cursor around, a brief description of each section of the screen will appear here.

GAME SELECTION SCREEN

After you have chosen a transport and finished with its setup screen, a screen with the following selections will appear.

ROOMS — Listed here are the Pilots' Lounge, where anyone looking for a game can talk to other prospective warriors, and Ready Rooms, where you can find out which warriors have joined certain games. Highlight the Ready Room of the host whose game you wish to play, then click the **JOIN** button.

WARRIORS — If you highlight a Ready Room, then the callsigns of the warriors joining that mission will be listed here.

INTERCOM — This area serves as a communication link between warriors. Click in the smaller bottom section and type your message, then press **Enter** to send it to everyone in the same room or lounge as you. All messages will appear in the larger top section.

QUICK HELP — As you move your cursor around, a brief description of each section of the screen will appear at the bottom of the screen.

BACK — Click this button to return to the Transport Selection Screen.

JOIN — Click this button to join a Pilot's Lounge or Ready Room.

HOST — Click this button if you wish to host a game. Note: Only those warriors with an original **MechWarrior 2 CD** in their CD drive can host a game.

QUIT — Click this button to exit *NetMech* and retreat to the safety of your operating system.

MISSION SETUP SCREEN

In an adaptation of the ancient Clan tradition of the batchall, the site and method of each confrontation are decided before combat begins. The Mission Setup Screen offers choices of missions and battle conditions. Because the privilege of making choices is reserved solely for game hosts, this screen only appears if you choose to host a game. Other warriors may offer suggestions and debate the host's wisdom, but in the end they must agree to abide by his or her conditions (or join another mission).

Note: If you choose to join a game, rather than host, the Mission Information Screen will appear instead.

FREE FOR ALL — Click here and then use the left or right scrolling arrow to see a list of free-for-all missions in which you are the only representative of your Clan fighting alone against warriors of other Clans.

TEAM — Click here and then use the left or right arrow to scroll through a list of team missions in which you and other warriors of your Clan will face a rival Clan. Note: You can click on the Clan logos in order to cycle through the various logos and select appropriate ones for each of the teams.

INTERCOM — This area serves as a communication link between warriors, and is invaluable during mission setup especially if you're playing on teams. Click in the smaller bottom section and type your message, then press **Enter** to send it to all the warriors who have joined the mission. Messages that other warriors send to you will appear in the larger top section.

QUICK HELP — As you move your cursor around, a brief description of each section of the screen will appear at the bottom of the screen.

OPTIONS — The following options allow you to shape the style of combat by implementing or avoiding certain aspects of 'Mech warfare:

Regeneration — If this option is chosen, warriors can rejoin combat after dying. Press the **Spacebar** to resurrect your destroyed 'Mech.

Unlimited Ammo — If this option is chosen, all warriors are provided with an inexhaustible supply of ammunition (i.e., missiles, machine guns, auto cannons and Gauss rifles).

Heat Tracking — If this option is chosen, 'Mechs are affected by the heat they naturally generate and are susceptible to overheating. If not selected, 'Mechs are unaffected by heat.

Splash Damage — If this option is chosen, 'Mechs will sustain damage from weapons, ammo or missiles exploding nearby. If not selected, 'Mechs are immune to this damage.

Collision Damage — If this option is chosen, 'Mechs will be damaged by falling or colliding with other objects. If not selected, 'Mechs are immune to this damage.

Radar — If this option is chosen, 'Mechs are equipped with radar that allows them to locate, track and automatically target other warriors. If not enabled, targeting must be done manually (by moving the target reticle over the enemy 'Mech and pressing the letter **Q**). Note: If this option is enabled, **F2** will toggle this option ON and OFF while in battle; **F2** also toggles visibility of the overhead map and auto-targeting.

Weight Limit — This option allows the host to determine the maximum weight limit for each 'Mech, from 25 to 100 tons.

Gravity — The gravity of battle sites can be set to any number from 0.25 to 4.0, altering the effectiveness of jumpjets and the speed of 'Mechs.

Time of Day — This option allows the host to determine when the mission will begin: dawn, day, dusk or night.

Temperature — This option allows the host to determine how quickly 'Mechs will heat up and cool down; the choices are Cold, Normal and Hot.

BACK — Click this button to return to the Game Selection Screen.

ACCEPT SETUP — Once all participants have agreed on the conditions of battle, click this button to proceed to the Clans Screen.

QUIT — Click this button to exit *NetMech* and retreat to the safety of your operating system.

MISSION INFORMATION SCREEN

This screen shows the mission and conditions that are being selected by the host, and only appears if you choose to join a game. When the host is finished establishing the mission conditions, the Clans Screen will appear.

Note: If you choose to host a game, the Mission Setup Screen will appear, rather than this one.

INTERCOM – This area serves as a communication link between warriors, and is invaluable during mission setup especially if you're playing on teams. Click in the smaller bottom section, type your message and press **Enter** to send it to all who have joined the mission. Messages that others send to you will appear in the larger top section.

QUICK HELP – As you move your cursor around, a brief description of each section of the screen will appear at the bottom of the screen

MISSION – The name of the mission chosen by the host is shown here.

OPTIONS – Listed here are the mission conditions established by the host. These options can only be changed by the host. Note: You can let the host know your preferences by communicating via **INTERCOM**.

BACK – Click this button to return to the Game Selection Screen.

QUIT – Click this button to exit *NetMech* and retreat to the safety of your operating system.

CLANS SCREEN

This screen allows warriors in a team mission to identify their Clan affiliations once the conditions of the battle have been accepted.

Warriors are randomly divided into two teams. If you wish to betray your Clan and switch to the enemy, click the **CHANGE** button. Note: you do not need to highlight your name, since you can only change your own Clan affiliation.

Note: In free-for-all missions, warriors can select their own Clan logos to be displayed on their 'Mechs – just cycle through the logos by clicking on the on-screen logo.

INTERCOM — This area serves as a communication link between warriors. Click in the smaller bottom section and type your message, then press Enter to send it to all the warriors who have joined the mission. Messages that other warriors send to you will appear in the larger top section. Note: If you are playing a team mission, you may send messages to ALL warriors engaged in the mission or to your CLAN only; click to light up the appropriate box.

QUICK HELP — As you move your cursor around, a brief description of each section of the screen will appear at the bottom of the screen

BACK — If you are hosting a game, this button will return you to the Mission Setup Screen. If you are joining a game, this button will return you to the Game Selection Screen.

CLANS — Clicking this button has no effect because you are already in the Clan Selection Screen.

MISSION — Click this button to enter the Mission Summary Screen, where you will see a final summary of the mission.

'MECH — Click this button to enter the 'Mech Selection Screen, where you can choose your 'Mech configuration.

DROPSHIP — Click this button to enter the Dropship Launch Screen where you can indicate that you are ready to engage the enemy.

QUIT — Click this button to exit *NetMech* and retreat to the safety of your operating system.

MISSION SUMMARY SCREEN

This screen gives the final summary of the mission. It lists the mission name and briefing, and the conditions of combat.

OPTIONS — Listed here are the mission conditions established by the host. If you would like any of the conditions changed, this is your last chance to voice your opinion by communicating via **INTERCOM**.

Note: For descriptions of the remaining buttons, see the "Clans Screen" section.

'MECH SELECTION SCREEN

With widespread warfare breaking out between the Clans, the technician caste has been overwhelmed, and tech support has been reduced to simple repairs. As a result you will not be able to build your own 'Mech as you could in *MechWarrior 2* and *Ghost Bear's Legacy*. You can, however, select a chassis and some variants. It is also possible for you to design a 'Mech in the MechLab within the original *MechWarrior 2*. As long as *NetMech* was installed in the same directory as the original *MechWarrior 2*, your custom 'Mech will be transported to this quadrant of the universe automatically upon saving and will be available in the NetMech 'Mech Selection Screen.

Click on the outer arrows to scroll through the various 'Mech chassis; click on the inner arrows to scroll through the alternate configurations of 'Mechs.

Note: For descriptions of the remaining buttons, see the Clans Screen section.

DROPSHIP LAUNCH SCREEN

This screen lists the callsigns of all the warriors and allows you to launch into the NetMech mission. If the box next to a player's name is lit up, that player has clicked the **LAUNCH** button and is ready for battle. If you have clicked **LAUNCH** and the box next to your name is not lit or if the **LAUNCH** button is disabled, then you should review the mission options by going back to the Mission Summary Screen because one of several possibilities may have occurred:

- The host has made some changes.
- You have not accepted the changes to the mission.
- Your 'Mech is now invalid because the host has changed the parameters of the mission.
- The host has selected an invalid option for that particular mission.
- Another warrior has joined the mission or someone has changed Clans.

When all warriors have clicked the **LAUNCH** button and lit boxes appear next to all names, everyone will be transported to the selected planet to commence combat.

COCKPIT RESOLUTION – You can choose between 320x200, 640x480 and 1024x768 by clicking to cycle through the choices. The lower the resolution, the faster the gameplay.

BACK – If you are hosting a game, this button will return you to the Mission Setup Screen. Otherwise it returns you to the Game Selection Screen.

Note: For descriptions of the remaining buttons, see the "Clans Screen" section.

MISSION RESULTS SCREEN

This screen gives information about the mission just completed, including the score for each callsign and who completed the mission successfully. Click **OK** to end the mission.

ADVANCED NETMECH FEATURES

You can take advantage of the following new features while you are engaged in a *NetMech* mission:

- After your 'Mech is destroyed (if the Regeneration option is not selected), you can still track other warriors by pressing the **Spacebar** to toggle through the warriors' callsigns and by pressing **Ctrl** and the **Arrow Keys** to maneuver your camera.
- You can chat with other warriors while on the battlefield by pressing **Ctrl+Fl** or **B** to access a window in which to type your message. After typing your message, press **Enter** to send it to all warriors; in a team mission you can send it to your starmates by pressing **Ctrl+F** or to your enemies by pressing **Ctrl+E**. Press **Esc** to abort.
- You can also chat with specific warriors while on the battlefield. The function keys **F2** through **F8** are assigned to individual warriors. Press **Ctrl+F?** (the key corresponding to the warrior with whom you wish to chat), then type your message and press **Enter**. Press **Esc** to abort.

TROUBLESHOOTING

An up-to-date troubleshooting guide is available on your CD in two formats, ASCII Text and Microsoft Windows Help. Use a text editor or word processing program to view the C:\NETMECH\NETMECH\NETINFO.TXT file. From within Windows, double-click on the C:\NETMECH\NETMECH\NETINFO.HLP file.

MECHWARRIOR 2

GAME CREDITS

PRODUCTION

Director John Spinale
Producer Josh Resnick
Lead Game Designer Sean Vesce
Game Designer/Writer Zachary Norman
Associate Game Designers Chad Findley
Ken Hullett
David White
Production Coordinators Lars Fuhrken-Batista
Andrew Held
Production Assistant Jeehun Hwang

PROGRAMMING

Simulation Programmers John Clarke
Michael Douglas
Scott Eiherton
John Keating
Tim Morten
Bob Mortensen
Eric Peterson
Dan Stanfill
Dave Zobel
Shell Programmers James Anhalt, III
John Peck, Jr.
Additional Programming David White
Programming Interns Brian Jennings
Daniel Kamins
Tools/Drivers Licensed from John Miles
John Lemberger
John Ratcliff
Installer Greg Sanborn,
Quicksilver Software

ART

Simulation Color, Lighting,
Textures, and Animations Danny Matson
Additional Simulation Art Direction Danny Matson
3-D Simulation Models and Animations J.J. Franzen
Additional 3-D Simulation Geometry Sean Kinnear
Shell Stills and Animations Direction Jefferson Elliot
Shell Stills and Animations Jack Burton
Scott Goffman
Jim Mitchell
Intro Movie by DIGITAL DOMAIN:
Executive Producer Chris McKibbin
Director of Animations Darnell Williams
Character Animation Craig Caton
Compositing Supervisor Nathan Wilson
Additional Compositing Steve Gray
Color & Lighting Consultant Daniel Robichaud
Unit Production Manager Susan Thurmond

AUDIO

Music and Sound Director Kelly Rogers
Original Musical Score Gregory Alper
Additional Music Jeehun Hwang
Musical Scores for All Movie Sequences
and Trials of Grievance Jeehun Hwang
Musical Scores for Jade Falcon Clan Jeehun Hwang
Musical Scores for Wolf Clan Gregory Alper
Jeehun Hwang
Audio Engineer Michael Schwartz
MIDI Engineer Bill Black

Sound Design by
SOUNDELUX MEDIA LABS:
Sound Effects Supervision &
Sound Design Scott Martin Gershen
Michael Reagan
Teri Madsen
Caron Widner
Sound Effects Mastering Bryan Bowen
Voice-Over Talent Scott Martin Gershen
John Keating
Zachary Norman
Michael Reagan
Carol Ruggier

PACKAGING AND PROMOTIONAL MATERIALS

Creative Director Ron Gould
Documentation Manager Mike Rivera
Graphic Designer Jonathan Brown
Additional Cover Art Scott Goffman
Danny Matson
Package Copywriter Veronica Milito
Manual Designer Marcella Missirian
Manual Writer Veronica Milito
Manual Illustrations Zachary Norman
Pilot Note Illustration Erik Jensen

QUALITY ASSURANCE

Quality Assurance Director Jon Doellstedt
Quality Assurance Manager Dave Arnspiger
Lead Testers John Lafleur
Jack Mamais
Test Team Steven Bishop, Tom Butler,
Matthew Candler, Linus Chen,
Curtis Crockett, Matthew
Gibbs, George Hoyt, Nate
Marston, Elvis Murray, Daiva
Venckus, and Zack Wood
Additional Testers Keith Alexander, Kurt Barker,
Rick Baumgartner, Peter
Blumel, Willie Bolton, Judith
Chlipala, Ray Choi, Tyron

Chookolingo, Ingrid de Beus,
Andre Emerson, Sean
Espinoza, John Fair, Greg
Fulton, Seth Grenald, Daniel
Kamins, David King, Danny
Lee, Jacques LeMaire, Tim
McMahon, Michael O'Brien,
Chris Strompolos, Murali
Tegulapalle, Nadine
Theuzillot, David R. Tulo Jr.,
William Westwater, Paul
Wiley, and Troy Williams

External Beta Testers Weslee Bilodeau, Tod
Bilsborrow, Dave Bourque,
Charles Bowlby, Bill "Axor"
Brown, Paul Cabana, Alex
Chan, Gary & Dolly Cook, Rich
De Francesco Jr., Jesse Derks,
Mark Dittenber, Trent Ditto,
Sven Doersam, Pamela Dreizen,
Brian Eichler, David Ferrell, Carl
Finley, Robert George, Richard
Grochowski, Steven Hawley,
Cezanne Huq, James Jackson,
Brian James, Jody Johnson,
Mark Kaelin, Lenore Kaye, Bill
Kirkman, Shaun Klomp,
Stephen Lafleur, Matthew
Lewis, Ed Milovic, Ford Maxim,
Steven Mo, Dayle Moore, Mat
O'Connor, Scooter Oehlerking,
Anthony Pham, Richard Powell,
Alan Precourt, Karen Rapchak,
Mark Reindl, Donald Rinker,
Jason Robinson, John Roper,
Loring Rose, Joseph Ruffolo,
Jorja Rule, James Sablatura,
Rick Salvador, Julie Smith
Montgomery Spencer, Ryan
Tykwinski, Mike Udovic, and
Bernard Yee

FASA

3-D Rendering Assistance Jamie Marshall
 Original BattleTech Designs Donna Knutson
 Jamie Nelson
 Steve Venters
 BattleTech Background Material The Adventure Architects, Brent
 Carter, Rob Cruz, Evan
 Jameson, Rodney Knox, Sam
 Lewis, Bryan Nystul, Michael
 Pellicciotti, Boy Peterson, Diane
 Piron-Gelman and Sharon
 Turrier-Molvhill
 BattleTech Universe Creators Jordan Weisman
 L. Ross Babcock III

SPECIAL THANKS TO...

All the wives and girlfriends, John Clarke and Tim Morten (for the Second Coming), Dave and RJ (for their percussion talents), Doug Bambridge, John Bruther, Tyron Chookolingo, Brad Crystal, Roy the Wonder Boy, Nathalie Deschatres, Tom Dowd, Denny Thorley and Mort Weisman (FASA), Michael Fletcher, Alan Gershenfeld, Larry Goldberg, Vinod Gupta, Sarah Hanlon, Snoopy the Hamster, Eric Johnson, Brian Kelly, Edward Kilham and Kalani Streicher (Ronin Entertainment), Scott Lahman, Mitch Lasky, Maryanne Lataif, Alan Lazar, Howard Marks, Mom, Brad Pickering, Tom Sloper, Smacker Boy, Ben Tenn, Trey Watkins, The Original Production Crew, ...and all the other folks at Activision who helped this game come to life.

COPYRIGHT:

The enclosed software product is copyrighted and all rights are reserved by Activision, Inc. It is published exclusively by Activision, Inc. The distribution of this product is intended for the use of the original purchaser only and for use only on the computer system specified. Lawful users of this program are hereby licensed only to read the program from its medium into memory of a computer solely for the purpose of executing the program. Copying (except for one backup copy on those systems that provide for it), duplicating, selling, or otherwise distributing this product is a violation of the law. This manual and all other documentation contained herein are copyrighted and all rights are reserved by Activision, Inc. These documents may not, in whole or in part, be copied, photocopied, reproduced, translated, or reduced to any electronic medium or machine-readable form without prior consent, in writing, from Activision, Inc. Willful violations of the Copyright Law of the United States can result in civil damages of up to \$50,000 in addition to actual damages, plus criminal penalties of up to one year imprisonment and/or a \$10,000 fine. In addition, violations of the Copyright Law of other jurisdictions may result in civil damages and, in certain circumstances, criminal penalties.

© 1995 Activision, Inc.

Printed in the U.S.A.

MechWarrior, BattleTech, BattleMech and 'Mech are registered trademarks of FASA CORPORATION. Used with permission.

Uses Smacker Video Technology. Copyright (c) 1994 by Invisible, Inc. d.b.a. RAD Software.

Activision is a registered trademark of Activision, Inc. © 1995 Activision, Inc. All rights reserved.





MechWarrior is a registered trademark of FASA CORPORATION.
Activision is a registered trademark of Activision, Inc. © 1995 Activision, Inc. All rights reserved.

P/N 3082-05-1